

# ELITMAT

2021/1

ONLINE CATALOGUE



# Welcome to Dancop International GmbH



Dear customer,  
Dear Sir or Madam,

Safety by quality is our motto. The success started in 1975 in a Danish town called Slangerup, when Jørgen Grynnerup started to manufacture industrial, traffic and safety mirrors made of synthetic material.

Logistics and sales are realized by Dancop International in Peine. The central position in Europe and the multilingual sales team provide perfect service.

We are happy to help you!

Nowadays, the company is successfully managed in the 2nd generation by Peter Grynnerup. The production progressed through the years by using latest technology.

Highest quality and highest safety standards are what we focus on. The same applies to our latest product group d-flexx, launched in 2017.

The strengths of Dancop:

1. Innovation and development
2. Flexibility and fast delivery
3. High quality
4. Products fitting your demand
5. Customized items even in small series

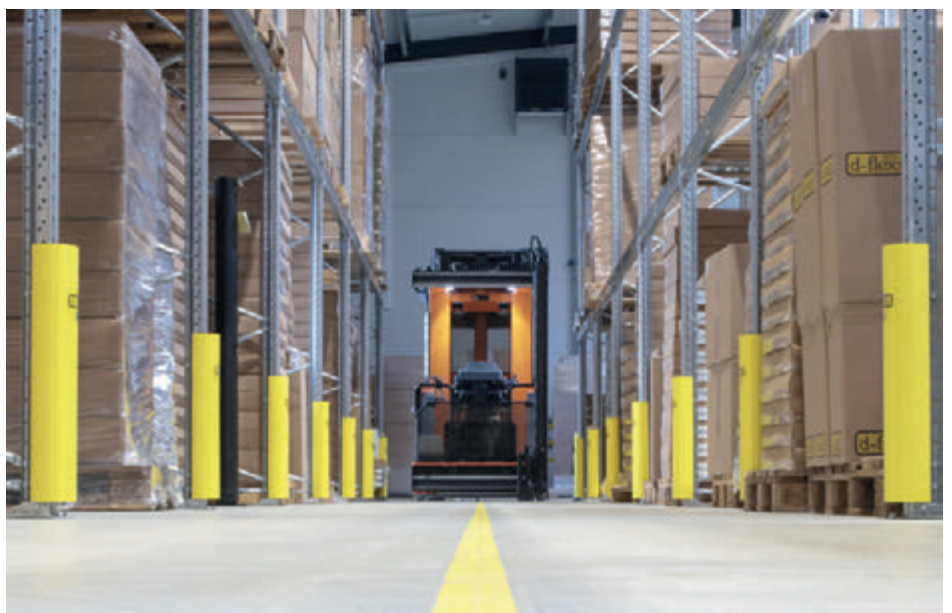



# d-flexx

## FLEXIBLE IMPACT PROTECTION



- Flexible impact protection made in our own production
- The flexible material deforms upon impact and afterwards returns to its original shape
- For in- and outdoor use
- 100% recyclable
- Easy installation - fixing material included in the delivery
- Considerably minimizes maintenance costs
- Customized products for perfect fit

Product video



Scan me!

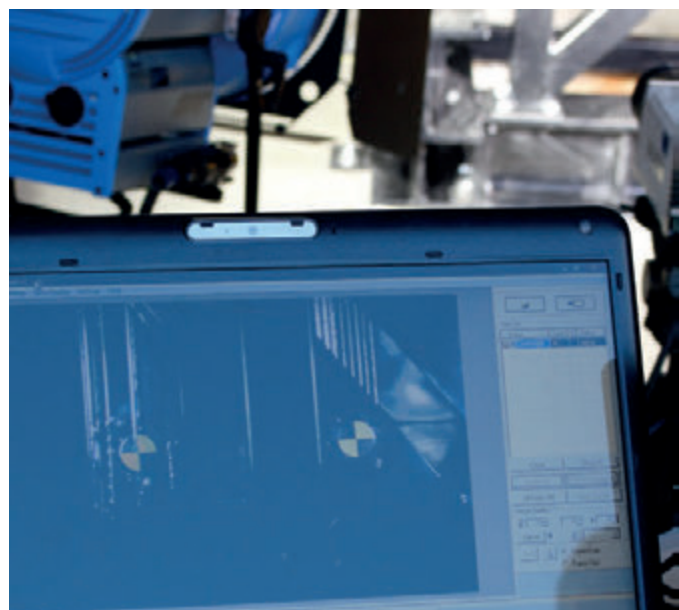



## RACK GUARD "ALFA"

The rack guard "Alfa" from our d-flexx series is an innovative protection for shelves.

The easy installation without additional tools allows for a quick application and fast annual rack inspections.

The rack guard is clicked directly onto the shelf, this way the floor remains undamaged in case of collisions.

The d-flexx rack protection "Alfa" is available in three different heights: 400 mm, 600 mm and 1000 mm, for rack legs 75-100 mm and 100-125 mm.



Photo: DR-RG-1

Rack guard "Alfa" made of polyethylene

Art. No.	Height	For rack legs	Weight
DF-RG-1	600 mm	75 - 100 mm	1,0 kg
DF-RG-2	600 mm	100 - 125 mm	1,2 kg
DF-RG-3	400 mm	75 - 100 mm	0,7 kg
DF-RG-4	400 mm	100 - 125 mm	0,9 kg
DF-RG-5	1000 mm	75 - 100 mm	1,5 kg
DF-RG-6	1000 mm	100 - 125 mm	2,1 kg



**MODULAR**

# TRAFFIC BARRIER PLUS "ECHO"

The flexible traffic barrier plus "Echo" is a combination of the d-flexx modules "Charlie" and "Delta". The additional heavy pipe in the lower part of the traffic barrier provides extended protection in pedestrian areas.

The fixing material is included in the delivery.

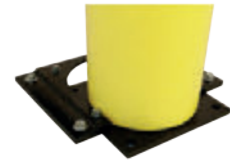

Photo: DFVB-SP  
Slider plate

**Traffic barrier PLUS "Echo", made of polyethylene, post height 1.200 mm, base plate 225 x 225 mm**

Art. No.	Description	Width	Weight
DFVB+E	End post	800 mm	17,0 kg
DFVB+M	Middle post	1000 mm	17,2 kg
DFVB+M+W90L	Echo on Delta corner post 90° left	600 mm	14,6 kg
DFVB+M+W90R	Echo on Delta corner post 90° right	600 mm	14,6 kg
DFVB+H1	Beam set: 3 beams, 1.510 mm, Ø 63 mm and 1 pipe 930 mm, Ø 160 mm		7,2 kg
DFVB+HI	Beam set: 3 beams, 1.510 mm, Ø 63 mm and 1 pipe 930 mm, Ø 160 mm		4,05 kg / m
DFVB-SP	Slider plate 330 x 240 mm, steel		3,2 kg



## FLEXIBLE SAFETY BARRIER "DELTA"

The flexible safety barrier "Delta" is an innovative separation of pedestrian areas and driveways. Customized solutions can always be supplied.

The fixing material is included in the delivery.

**Flexible safety barrier "Delta", made of polyethylene, post height 1.200 mm, post Ø 110 mm, base plate 225 x 225 mm**

Art. No.	Description	Weight
DFFS-M-E	End post	8,0 kg
DFFS-M-M	Middle post	8,0 kg
DFFS-M-W90	90° corner post	8,0 kg
DFFS-M-T	T-post	8,0 kg
DFFS-M-K	Cross post	8,0 kg
DFFS-H1	Beam set: 3 beams, 1.510 mm	4,5 kg
DFFS-HI	Beam set: 3 beams, customized length 350-1.510 mm	3 kg / m
DFFS-B110	Bollard	8,7 kg
DFFS-SP	Slider plate 330 x 230 mm, steel	4,4 kg



**Customized items available ex works!**





**MODULAR**

## FLEXIBLE SAFETY BARRIER "DELTA"

In addition to the standard "Delta" safety barrier, we offer you two versions of the "Delta" barrier with four beams in height 1.200 mm and 1.600 mm. The „Delta“ barrier in 1.200 mm height with four beams offers even more protection with a distance of only 329 mm to the ground.

The fixing material is included in the delivery.

**Flexible safety barrier "Delta", made of polyethylene, post Ø 110 mm, base plate 225 x 225 mm.**

Description	Height 1200 mm Art. No.	Weight	Height 1600 mm Art. No.	Weight
End post	DFFS-M-4E	8,7 kg	DFFS-M1600-4E	10,4 kg
Middle post	DFFS-M-4M	8,7 kg	DFFS-M1600-4M	10,4 kg
90° corner post	DFFS-M-4W90	8,7 kg	DFFS-M1600-4W90	10,4 kg
T-post	DFFS-M-4T	8,7 kg	DFFS-M1600-4T	10,4 kg
Cross post	DFFS-M-4K	8,7 kg	DFFS-M1600-4K	10,4 kg
Beam set: 4 beams, 1.510 mm	DFFS-M-4H1		DFFS-M-4H1	6 kg
Beam set: 4 beams, customized length 350-1.510 mm	DFFS-M-4HI		DFFS-M-4HI	6 kg
Slider plate 330 x 230 mm, steel	DFFS-SP	4,4 kg	DFFS-SP	4,4 kg



**Customized items available ex works!**



## TRAFFIC BARRIER "LIMA"

The flexible traffic barrier "Lima" is a combination of the d-flexx modules "Delta" and "Hotel". Due to the additional pipes in the lower part of the traffic barrier it is suitable for heavy duty traffic.

The fixing material is included in the delivery.

**Traffic barrier "Lima", made of polyethylene, post height 1.200 mm, base plate 225 x 225 mm**



Art. No.	Description	Width	Weight
DFDH-M-E	End post	600 mm	19,2 kg
DFDH-M-M	Middle post	1000 mm	20,9 kg
DFDH-M-H1	Beam set: 2 beams, 1.510 mm, Ø 63 mm and 2 pipes 930 mm, Ø 160 mm		9,5 kg
DFDH-M-HI	Beam set: 2 beams, 980-1.510 mm, Ø 63 mm and 2 pipes Ø 160 mm customized length		9,5 kg / m
DFVB-SP	Slider plate 330 x 240 mm, steel		3,2 kg



**Customized items available ex works!**





**MODULAR**

# TRAFFIC BARRIER SINGLE RAIL "CHARLIE" TRAFFIC BARRIER DOUBLE RAIL "HOTEL"

The flexible traffic barrier "Charlie" provides optimum protection for machines, inventory, and employees. Thanks to the easy and fast assembly in combination with customized lengths, traffic routes can quickly be separated from work areas or pedestrian paths. The traffic barrier "Hotel" provides an even larger protection zone, due to the double pipes and higher posts.

**Traffic barrier double rail "Hotel", modular, height 760 mm, made of polyethylene, post Ø 200 mm, base plate 225 x 225 mm**

**Traffic barrier single rail "Charlie", modular, height 516 mm, made of polyethylene, post Ø 200 mm, base plate 225 x 225 mm**



Art. No.	Description "Charlie"	Height	Weight
DFVB-E	End post	516 mm	12,8 kg
DFVB-M	Middle post	516 mm	13,6 kg
Art. No.	Description "Charlie"	Length	Weight
DFVB-R	Standard pipe Ø 160 mm	930 mm	2,6 kg
DFVB-I	Standard pipe Ø 160 mm	indivi. 400 - 929 mm	2,8 kg / m
DFVB-SP	Slider plate 330 x 240 mm, steel		3,2 kg

Art. No.	Description "Hotel"	Height	Weight
DFVBD-E	End post	760 mm	14,5 kg
DFVBD-M	Middle post	760 mm	15,9 kg
Art. No.	Description "Hotel"	Length	Weight
DFVBD-R	2 Standard pipes Ø 160 mm	930 mm	5,2 kg
DFVBD-I	2 Standard pipes Ø 160 mm	indivi. 2 x 400 - 929 mm	5,2 kg / m



**Customized items available ex works!**



Photo: "Charlie"

Photo: "Hotel"

## RACK END PROTECTION "GOLF"

The flexible rack-end barrier "Golf" protects rack ends both in- and outdoors.

Once installed, the rack end is not in contact with the rack. This allows the rack end protection to absorb impact energy.

Cost and time-consuming maintenance is reduced to a minimum. Furthermore, the moveable cuffs on the posts deflect impact energy.

The double rail version is for driveways with heavy pallet trucks.

The fixing material is included in the delivery.

**Rack end protection "Golf", made of polyethylene, pipe Ø 160 mm, base plate 225 x 225 mm**

Art. No	Description	Width	Height	Weight
DFRE1-2	Rack end protection, single rail	1100 mm	516 mm	23,6 kg
DFRE1-4	Rack end protection, single rail	2500 mm	516 mm	26,2 kg
DFRE2-2	Rack end protection, double rail	1100 mm	760 mm	25,6 kg
DFRE2-4	Rack end protection, double rail	2500 mm	760 mm	28,6 kg

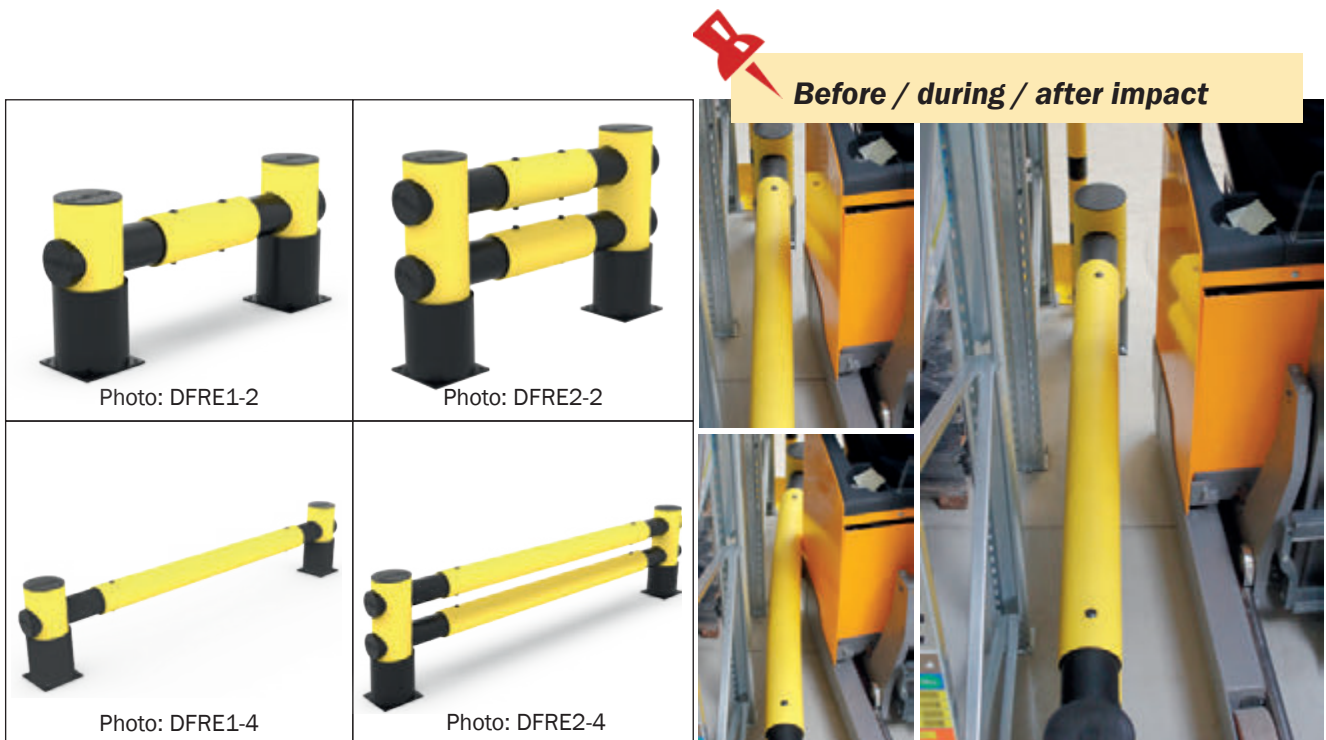



# MACHINE PROTECTION FENCE "FOXTROT"

## MACHINE PROTECTION FENCE "KILO"

The flexible d-flexx machine protection fences "Foxtrot" and "Kilo" are a fast and easy way to separate work areas and routes. These products are delivered pre-assembled and can be installed without further assembly. The outer sides are equipped with additional handrails to further extend the protection area.

The fixing material is included in the delivery.

**Machine protective fencing "Foxtrot" and "Kilo", made of polyethylene, height 1.200 mm, pre-mounted, with base plate 225 x 225 mm**

Art. No.	Description "Foxtrot"	Width	Weight
DFFS-FU1	Machine protection fence	1000 mm	17,0 kg
DFFS-FU2	Machine protection fence	1500 mm	19,0 kg
DFFS-FU3	Machine protection fence	2000 mm	22,0 kg
DFFS-SP	Slider plate, steel	330 x 230 mm	4,4 kg

Art. No.	Description "Kilo"	Width	Weight
DFKI+FU1	Machine protection fence	1000 mm	41,1 kg
DFKI+FU2	Machine protection fence	1500 mm	44,5 kg
DFKI+FU3	Machine protection fence	2000 mm	47,4 kg
DFVB-SP	Slider plate, steel	330 x 240 mm	3,2 kg



Photo: DFVB-SP



Photo: DFFS-SP



Photo: DFKI+FU1



Photo: DFFS+FU1



Photo: "Foxtrot"



Photo: "Kilo"

## ANDERRIDE GUARD "MIKE"

The flexible kerb barrier "Mike" is the ideal product to protect walls and assembly lines from collisions in floor area. Its round shape allows for a diversion of force in case of an impact. The kerb barrier "Mike" can be combined with most of the d-flexx series for a full safety solution.

As our other products, it is made from special material to absorb the impact force and return into its original shape. It is easily installed and a cost-effective way to prevent collisions.

The fixing material is always included in the delivery.  
The height of the kerb barrier is 140 mm.

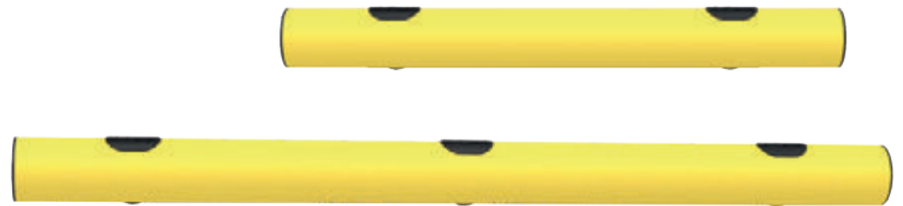

Art. No.	Description	Length	Weight
DFKB-1	Anderride guard ø 140 mm	1300 mm	5,9 kg
DFKB-2	Anderride guard ø 140 mm	2000 mm	8,5 kg
DFKB-3	Anderride guard ø 140 mm	1500 mm	6,8 kg
DFKB-4	Anderride guard ø 140 mm	1000 mm	4,9 kg
DFKB-5	Anderride guard ø 140 mm	500 mm	3,2 kg
DFKB-I	Anderride guard ø 140 mm	Customized length 400 - 1499 mm	6,6 kg
DFKB-I2	Anderride guard ø 140 mm	Customized length 1501 - 1999 mm	8,5 kg

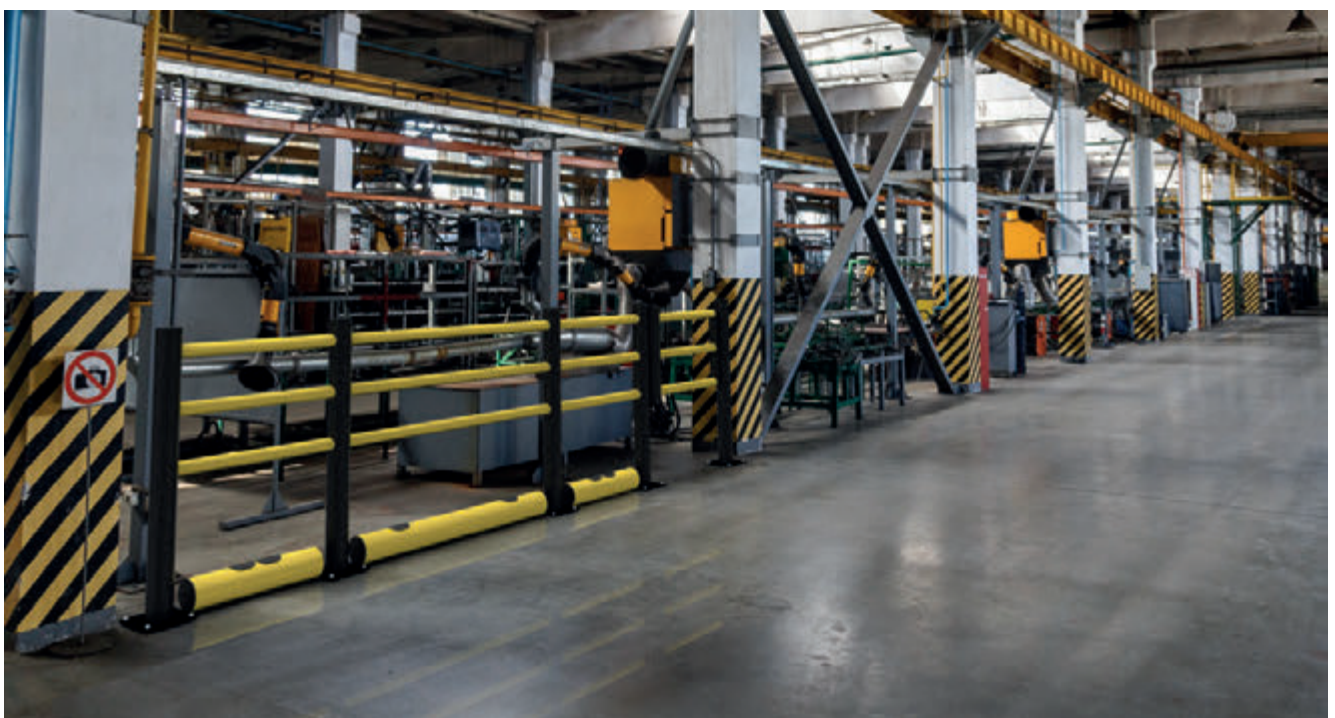

**MODULAR**

# SWING GATE "JULIET"

The swing gate "Juliet" can be integrated into a "Delta" and "Echo" system or installed alone with a "Delta" or "Echo" post. At a width of 1.500 mm or more, the swing gate "Juliet" comes with a wheel. The swing gate "Juliet" is delivered with maintenance-free hydraulic hinges. The fixing material is included in the delivery.

**D-flexx "Delta" post for "Juliet" swing door, made of polyethylene, post Ø 110, height 1.200 mm**

Art. No.	Description	Weight
DFJU-TM	Delta middle post for Juliet swing gate	12,8 kg
DFJU-TT	Delta T-post for Juliet swing gate	16,7 kg
DFJU-TW90L	Delta corner post 90° for Juliet swing gate left	15,7 kg
DFJU-TW90R	Delta corner post 90° for Juliet swing gate right	15,7 kg
DFJU-TE	Delta end post for Juliet swing gate	12,8 kg
DFJU-DA800	Juliet swing gate 800 mm	11,6 kg
DFJU-DA1000	Juliet swing gate 1000 mm	12,3 kg
DFJU-DA1200	Juliet swing gate 1200 mm	13,0 kg
DFJU-DA1500	Juliet swing gate 1500 mm with wheel	15,3 kg
DFJU-DA1750	Juliet swing gate 1750 mm with wheel	15,9 kg
DFJU-DA2000	Juliet swing gate 2000 mm with wheel	16,8 kg
DFJU-DATK1	Juliet swing gate customized size 801-1199 mm	13,0 kg
DFJU-DATK2	Juliet swing gate customized size 1.201-1.999 mm	16,8 kg
72118	Gate-stop, black	0,7 kg

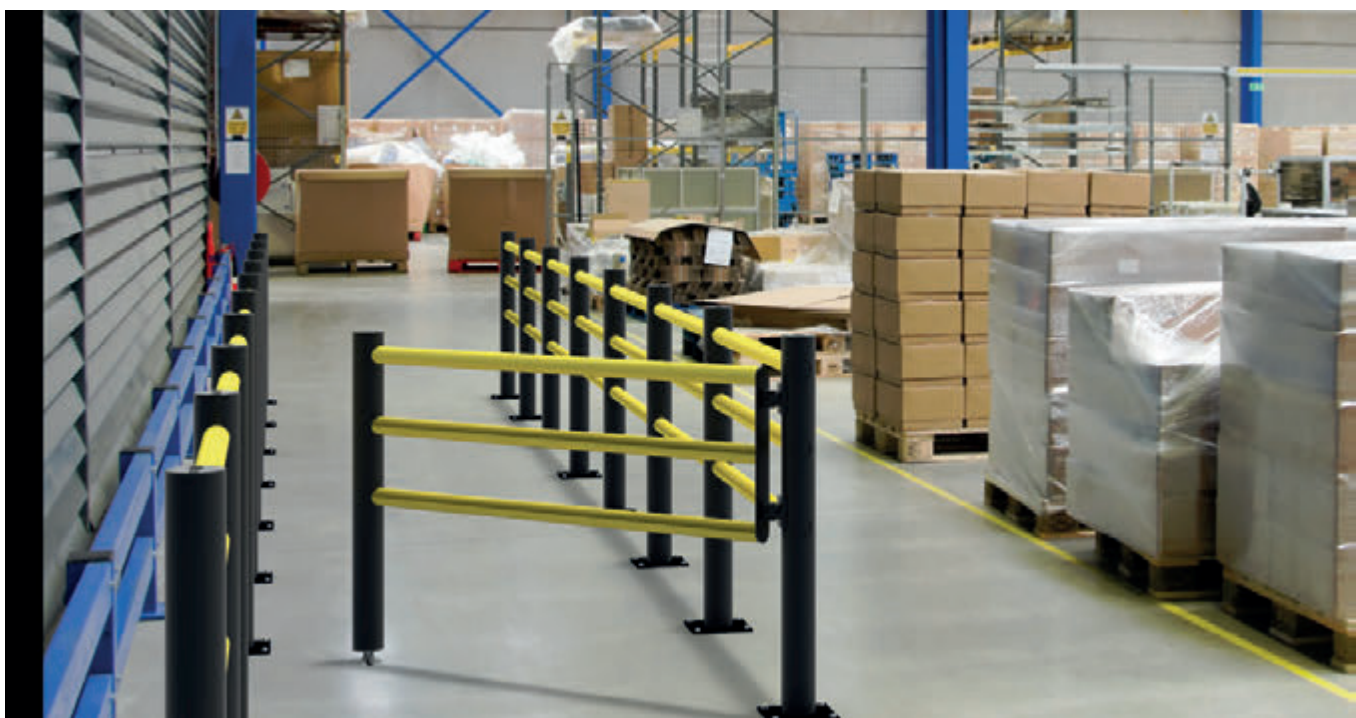



## SWING GATE "JULIET"

The swing gate "Juliet" can be integrated into a "Delta" and "Echo" system or installed alone with a "Delta" or "Echo" post. At a width of 1.500 mm or more, the swing gate "Juliet" comes with a wheel. The swing gate "Juliet" is delivered with maintenance-free hydraulic hinges.

The fixing material is included in the delivery.

**D-flexx "Echo" post for "Juliet" swing gate, made of polyethylene, post Ø 200, height 1.200 mm**

Art. No.	Description	Weight
DFJU+TM	Echo middle post for Juliet swing gate	12,8 kg
DFJU+TT	Echo T-post for Juliet swing gate	16,7 kg
DFJU+TW90L	Echo corner post 90° for Juliet swing gate left	15,7 kg
DFJU+TW90R	Echo corner post 90° for Juliet swing gate right	15,7 kg
DFJU+TE	Echo end post for Juliet swing gate	12,8 kg
DFJU-DA800	Juliet swing gate 800 mm	11,6 kg
DFJU-DA1000	Juliet swing gate 1000 mm	12,3 kg
DFJU-DA1200	Juliet swing gate 1200 mm	13,0 kg
DFJU-DA1500	Juliet swing gate 1500 mm with wheel	15,3 kg
DFJU-DA1750	Juliet swing gate 1750 mm with wheel	15,9 kg
DFJU-DA2000	Juliet swing gate 2000 mm with wheel	16,8 kg
DFJU-DATK1	Juliet swing gate customized size 801-1199 mm	13,0 kg
DFJU-DATK2	Juliet swing gate customized size 1201-1999 mm	16,8 kg
72118	Gate-stop, black	0,7 kg



**NEW**



## DOCK GATE "NOVEMBER"

The flexible dock gate "November" provides safety in loading zones. During everyday use, the dock gate will convince you through its easy handling; it can be opened and closed by only one person. The built-in retaining spring prevents lowering or abrupt dropping of the tube which ensures a safe use. The combination with our other d-flexx products results in a complete barrier.

The fixing material is included in the delivery.

Art. No	Inside length	Total length	Width	Height	Weight
DFNO-W2300	2300 mm	2750 mm	585 mm	516 mm	56,2 kg
DFNO-W2600	2600 mm	3050 mm	585 mm	516 mm	58,3 kg
DFNO-WI	2300 - 3300 mm	2750 - 3750 mm	585 mm	516 mm	63,2 kg





## FLEXIBLE BOLLARD "BRAVO"

The flexible d-flexx bollard "Bravo" absorbs the impact energy. The special material prevents damage to both ground and vehicle.

Due to its robustness and high visibility, the bollard is the ideal product for protecting inventory and employees. An additional version featuring a revolving cuff complements the series.

The d-flexx-Bollards "Bravo" are available in heights of 516 mm, 760 mm, and 1.200 mm.

The fixing material is included in the delivery.

**Bollard "Bravo", made of polyethylene, with base plate 225 x 225 mm**

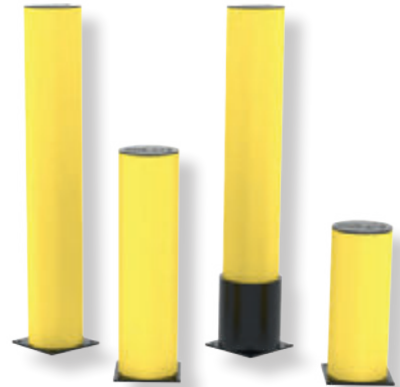

Art. No.	Description	Height	Pipe diameter	Weight
DFB050-10	Bollard	1200 mm	ø 200 mm	15,5 kg
DFB050-20	Bollard	760 mm	ø 200 mm	12,5 kg
DFB050-40	Bollard	516 mm	ø 200 mm	10,8 kg
DFB050-30	Bollard with rotatable cuff	1200 mmm	ø 225 mm	15,9 kg
DFVB-SP	Slider plate 330 x 240 mm, steel			3,2 kg

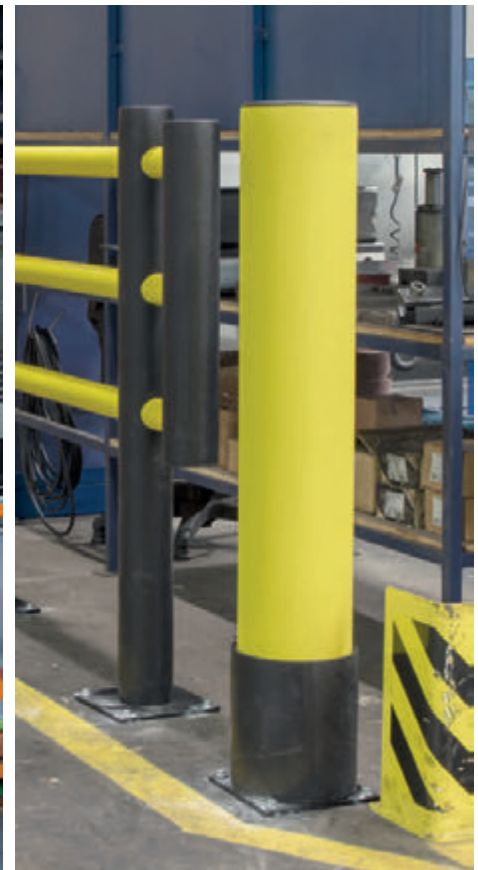





Storage and transport racks, loading safety



Guardrail



Impact protection made of steel

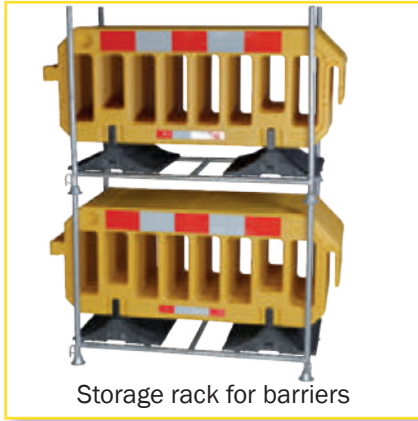

Storage rack for barriers



Parking security



Swing gate



Park stops



Column protection

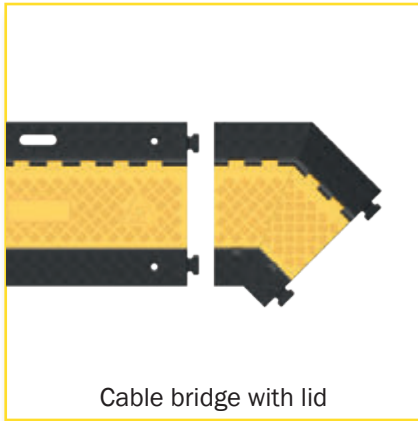

Cable bridge with lid



other RAL colors available



Customized versions possible!



Steel

## MODULAR SAFETY RAILING

This modular safety railing can be put together as per your needs.

Made of steel, galvanized and powder coated for outdoor use or only powder coated for indoor use.

Color: traffic yellow, like RAL 1023



**Beams for safety railing, cross section 80 x 140 mm, fixing material for beams included in the delivery.**

Length	Art. No. indoor use	Art. No. outdoor use	Weight
50 cm	B-50	B+50	6,0 kg
75 cm	B-75	B+75	9,5 kg
100 cm	B-100	B+100	11,0 kg
120 cm	B-120	B+120	13,5 kg
135 cm	B-135	B+135	13,8 kg
150 cm	B-150	B+150	14,2 kg
200 cm	B-200	B+200	22,0 kg



**Posts for safety railing, cross section 100 x 100 mm, base plate 200 x 200 mm, mounting via 4 drill holes à Ø 12,5 mm**

Description	Post 50 cm		Weight	Post 100 cm		Weight
	Art. No. indoor use	Art. No. outdoor use		Art. No. indoor use	Art. No. outdoor use	
End post	PE-50	PE+50	8,0 kg	PE-100	PE+100	14,0 kg
Middle post	PM-50	PM+50	10,0 kg	PM-100	PM+100	15,0 kg
Corner post	PW-50	PW+50	10,0 kg	PW-100	PW+100	15,7 kg
Single post				P-100	P+100	12,6 kg

**Floor anchor 85 mm, galvanized, Art. No. FIX1**

**Floor anchor set of 4 pieces Art. No. FIX4**

Photo:  
end post, middle post, corner post height 50 cm



Photo:  
end post, middle post, corner post, single post height 100 cm





Steel

## POST WITH REMOVAL BRACKETS

The posts with removal pockets of the modular TÜV-certified safety railing are used in areas where temporary access for maintenance work is necessary. The beams are inserted into the tabs and can be removed by hand without

additional tools. The tabs are processed to protect the coating to ensure a long service life.



Photo: PEE-100



Photo: PME-100



Photo: PWE-100



Photo: PMES-100

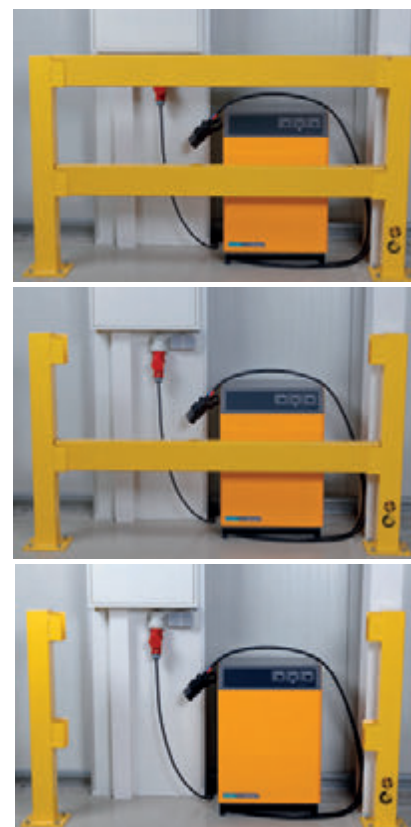

other RAL colors available



Customized versions possible!



Posts with removal brackets, steel, cross section 100 x 100 mm, powder coated for indoor use, yellow (like RAL 1023), base plate 200 x 200 mm, mounting via 4 drill holes à Ø 12,5 mm, TÜV-certified

Art. No.	Description	Weight
PEE-100	End post with removal bracket	13,5 kg
PME-100	Middle post with removal brackets on both sides	14,5 kg
PWE-100	Corner posts with removal bracket	14,5 kg
PMES-100	Middle post with removal bracket on one side, and permanent connection on the other	15,0 kg
FIX4	Floor anchor 85 mm galvanized set of 4 pieces	



Photo: unilateral removal bracket



Photo: removal bracket





other RAL colors available



Customized versions possible!



Steel

## SWING GATE

The swing gate for the TÜV-certified safety barrier is an effective solution to secure passageways. Due to the bent construction the swing gate is highly visible, even in longer sections.

The swing gate closes automatically to ensure a safe traffic flow and to minimize the risk of accidents.

The swing gate can also be placed within already existing safety barrier systems.



**We do your planning! [info@dancop.com](mailto:info@dancop.com)**



**135° opening, self-closing**



Photo: application example



Photo: scope of supply

**Swing gate, steel, self-closing, including 2 middle posts, width entire element 1.070 mm, height 1.000 mm, width swing gate 870 mm, height swing gate element 200 mm, distance floor to lower pipe 760 mm. Delivery pre-installed. Powder coated for indoor use, yellow (like RAL 1023), base plate 200 x 200 mm, mounting via 4 drill holes à 12,5 mm.**

Art. No.	Description	Total width	Passage width max.	Weight
SWTSG-	Swing gate	1070 mm	870 mm	33,2 kg
SWTWM	Swing gate made of steel for wall mounting, indoor use only, yellow (like RAL 1023), set consisting of swing gate element including mounting plate and stop, total width 870 mm, mounting plate 400 x 200 mm with 4 drill holes à Ø 13 mm, passage width 782 mm.			6,5 kg
FIX8	Floor anchor 85 mm galvanized set of 8 pieces			



**NEW**

## Steel SWING GATE

This swing gate for the TÜV-certified safety railing is a reliable solution for passageways with a required passage width of up to 2 m. The saloon door effect, in combination with the casters located at the lower part, let the doors return to the 0-position and close the passageway. The door can be secured in the 0-position by means of a retainer unit.

The door units are mounted on the posts, made of steel, and allow long-term use.

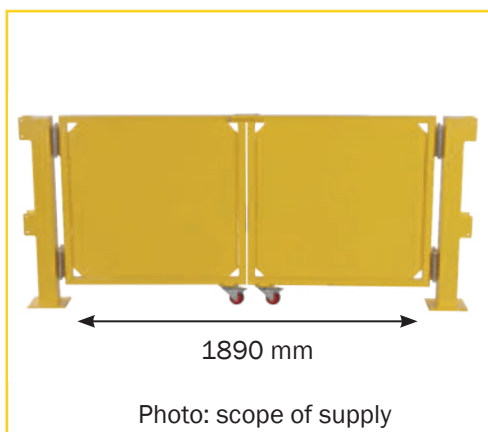

**Swing gate, steel, one unit includes 2 posts, pre-assembled: 2 posts 1.000 x 100 x 100 mm, 2 doors 995 x 900 mm, maximum passage width 2.000 mm, powder coated for indoor use, yellow (like RAL 1023), base plate 200 x 200 mm, mounting via 4 drill holes à Ø 12,5 mm, TÜV-certified**

Art. No.	Description	Total width	width per gate	Passage width	Height Door element	Weight
STSG-	Swing gate	2200 mm	995 mm	1890 mm	900 mm	38,5 kg
FIX8	Floor anchor 85 mm galvanized set of 8 pieces					



Photo: detailed views



**other RAL colors available**



**Customized versions possible!**





other RAL colors available



Customized versions possible!



Steel

## SLIDE GATE

The Slide Gate for the TÜV-certified Safety Barrier Steel is a safe solution to secure passageways up to 3 m.

The slide gate for the TÜV-certified safety barrier Steel is a safe solution to secure passageways up to 3 m. With the slide mechanism the slide gate can be easily opened, the gate parts do not block the passageway. When opening the gate, the cross braces slip into the beam set which allows safe and easy access. With the double-sided handle the gate can be easily opened and closed.

The slide gate comes pre-assembled and can be used free-standing, in combination with a slampost (Art. No. P-100, page 14) or in combination with a customized version of the TÜV-certified safety barrier system.

When planning a modular system, the end post which is included in the delivery, will be placed at the end of the safety barrier, and is replaced by a middle or corner post.



**Slide Gate, height 1.000 mm, one unit consisting of: 2 end posts à 1.000 x 100 x 100 mm, 2 beams 1.500 x 140 x 80 mm, 1 slide gate with a handle 1.000 mm, total width 2.760 mm, maximum passage width 1.000 mm, powder coated for indoor use, yellow (like RAL 1023), base plate 200 x 200 mm, floor mounting via 4 drill holes à Ø 12,5 mm, TÜV-certified.**

Art. No.	Description	Total width	Passage width	Weight
SBTSG-100	Slide gate	2760 mm	1000 mm	72,8 kg
SBTSG-150	Slide gate	3760 mm	1500 mm	86,3 kg
FIX8	Floor anchor 85 mm galvanized set of 8 pieces			

**With 2 gates à 1,5 m: maximum passage width 3,0 m possible!**

Photo: 2 x Art. No. SBTSG-150

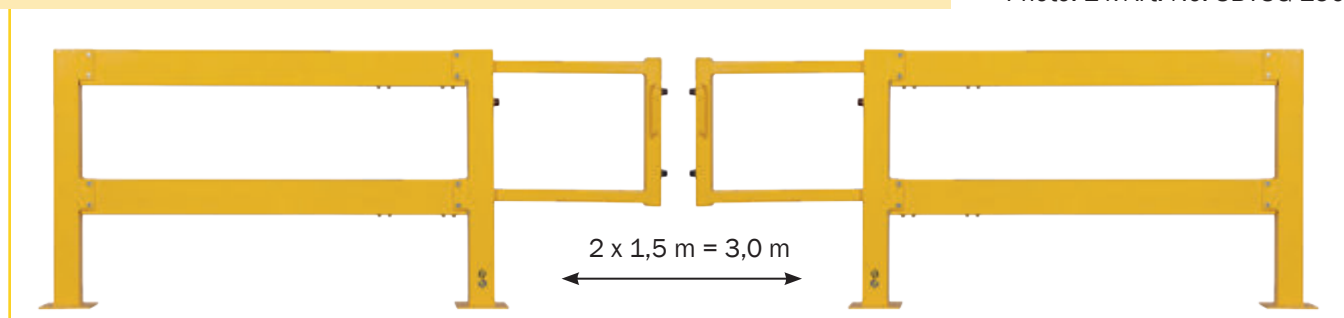





Steel

## EXPANSION MODULES

The TÜV-certified add-on modules for the safety barrier help increase safety and avoid damages and injuries in logistic and production areas.

The add-on modules can be integrated in new or already existing Dancop safety barriers. The reach-through and the anderride guard (page 20) help close the front of the safety barrier thereby preventing accidents.

The information board and mounting post (page 21) can be placed directly on the top beam of the safety barrier. On the information board important notes or information sheets can be placed. The mounting post enables the installation of safety mirrors to get an overview of the area. The XL-corner post is the perfect choice for areas with highly frequented traffic to grant optimal impact protection. The wall bracket (page 21) allows to fix the safety barrier on the wall, the magnet (page 22) and the magnetic tape cartridge (page 22) perfectly complete the assortment.



other RAL colors available



Customized versions possible!



Steel

## XL-POST

XL-Post, height 1.200 mm, Ø 159 mm, galvanized and powder coated for outdoor use or powder coated for indoor use, yellow (like RAL 1023), with black warning stripes, base plate 240 x 240 x 6 mm, floor mounting via 4 drill holes à Ø 12,5 mm, TÜV-certified.

Art. No.	Description	Weight
PW-XL+120	corner post, galvanized and powder coated	28,0 kg
PW-XL-120	corner post, powder coated	28,0 kg
PE-XL+120	end post, galvanized and powder coated	28,0 kg
PE-XL-120	end post, powder coated	28,0 kg
FIX4	Floor anchor 85 mm galvanized set of 4 pieces	



Photo: End post

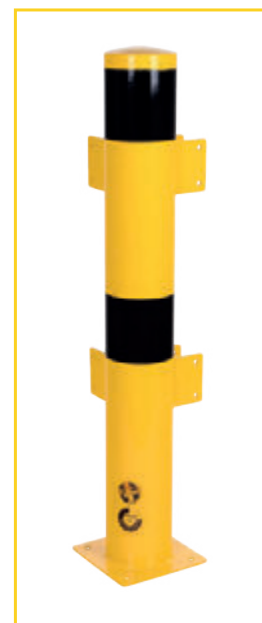

Photo: Corner post



other RAL colors available



Customized versions possible!



## ACCESSORIES FOR SAFETY BARRIER

### REACH-THROUGH GUARD

Reach-through guard for safety barrier, height 450 mm, powder coated for indoor use, yellow (like RAL 1023), mounting parts included, TÜV-certified.

Art. No.	Description	Weight
DSSG-50	Length 500 mm	3,1 kg
DSSG-100	Length 1000 mm	4,7 kg
DSSG-120	Length 1200 mm	5,9 kg
DSSG-135	Length 1350 mm	6,8 kg
DSSG-150	Length 1500 mm	7,8 kg
DSSG-200	Length 2000 mm	9,0 kg

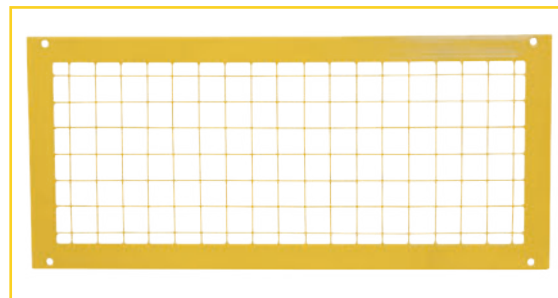
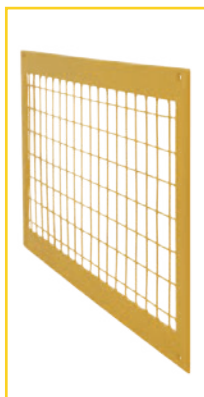

### ANDERRIDE GUARD

Anderride guard for safety barrier, height 490 mm, to be attached to the lower beam, powder coated for indoor use, yellow (like RAL 1023) with black warning stripes, TÜV-certified.

Art. No.	Description	Weight
UFSSG-50	Length 380 mm	8,5 kg
UFSSG-100	Length 880 mm	19,4 kg
UFSSG-120	Length 1080 mm	24,0 kg
UFSSG-135	Length 1230 mm	27,4 kg
UFSSG-150	Length 1380 mm	30,8 kg
UFSSG-200	Length 1880 mm	42,0 kg



### STORAGE BOX

Storage box for safety barrier, 250 x 125 x 100 mm, to be attached to the beam of the safety barrier, powder coated for indoor use, yellow (like RAL 1023), TÜV-certified.



Art. No.	Description	Width	Length	Height	Weight
LBSG-	Storage box	125 mm	250 mm	100 mm	2,0 kg



## INFO PANEL

Info panel for safety barrier, 800 x 1.000 mm, to be attached to the beam of the safety barrier, powder coated for indoor use, yellow (like RAL 1023), mounting parts included, TÜV-certified.

Art. No.	Description	Height	Weight
ITSG-100	Info panel width 1000 mm	800 mm	27,2 kg

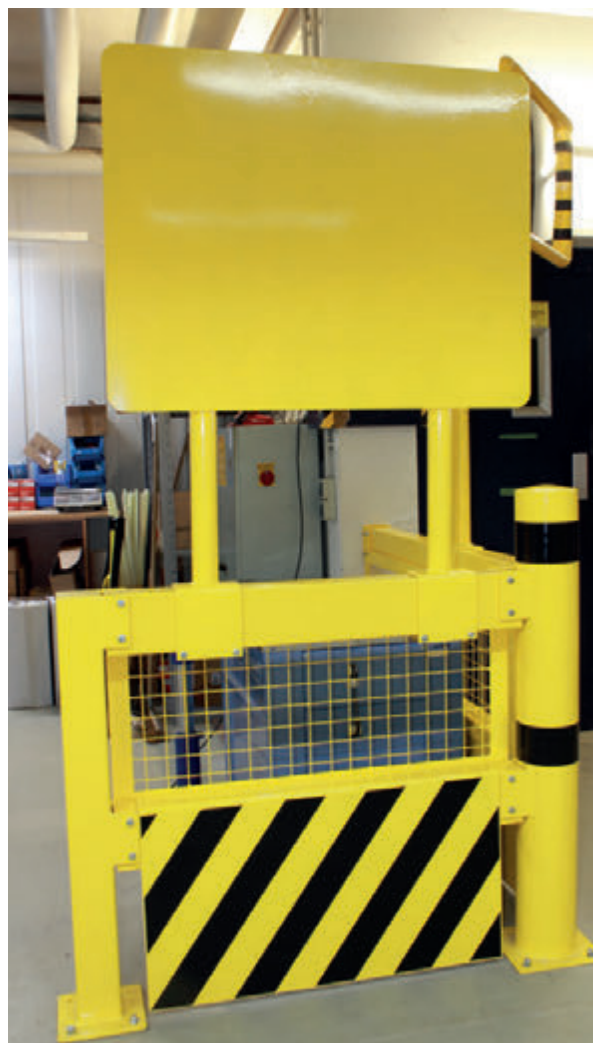
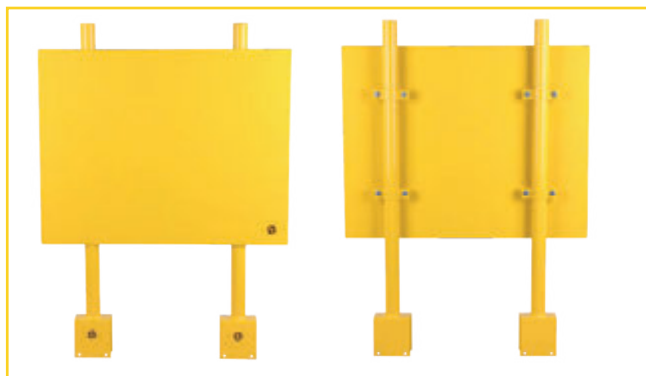

## MOUNTING POST

Post for mirrors or warning signs, height 1.200 mm, Ø 60 mm, powder coated for indoor use, yellow (like RAL 1023), mounting parts included, TÜV-certified.

Art. No.	Description	Height	Weight
SPSG-100	Post 60 mm for Mirror mounting	1200 mm	8,0 kg

## WALL BRACKET

The wall bracket is a cost-effective solution for fixing beams of the safety barrier on walls or other levelled surfaces. Screws and dowels for wall mounting are not included in the delivery.

**Wall bracket for safety barrier, 120 x 110 x 60 mm, galvanized and powder coated for outdoor use, yellow (like RAL 1023), TÜV-certified**

Art. No.	Description	Size	Weight
WSG+	Wall bracket	110 x 120 x 60 mm	1,5 kg







## MAGNETIC RETRACTABLE BARRIER



Retractable strap, 50 mm wide, magnetic end and magnetic fixing, with acrylic housing, maximum extension length 4.600 mm, diagonal stripes, 3 fixation magnets with 90 N holding force each, housing 118 x 143 x 85 mm

Art. No.	Color band	Color holder	Length	Weight
MGB-GS	Yellow-black	Yellow-black	4600 mm	1,0 kg
MGB-RW	Red-white	Red-black	4600 mm	1,0 kg

## MAGNET WITH HOOK - ADHESIVE FORCE APPROX. 30 KG

The hook magnet is a quick and easy way for installing chains on steel surfaces. The corresponding chain set is available separately.

**Hook magnet with M5 internal thread, total height 48 mm, magnet height 8 mm, Ø total 32 mm, Ø pin 10 mm, tolerance +/-0.1 mm, magnet with neodymium alloy, magnetisation/level N38, nickel-plated, adhesive force approx. 30 kg, max. operation temperature 80°**

Art. No.	Description	Height	Weight
TOMA+ZIH	Magnet with hook	48 mm	0,1 kg

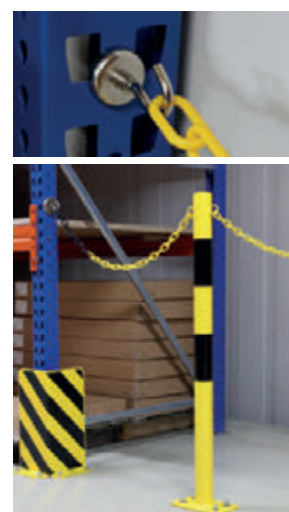



Steel

## SAFETY BARRIER Ø 48 MM

The safety barrier made of steel with a pipe Ø 48 mm is a great solution to separate drive- and pathways. The yellow and black coloring ensures high visibility.

With the different parts, including the unique variable post with a rotation angle of up to 270°, any conceivable design can be realized.

The individual components of this modular safety barrier are simply plugged together. The fixing material for floor mounting can be ordered separately.



 other RAL colors available



Customized versions possible!



Posts for safety barrier, Ø 48 mm, 2,9 mm material thickness, galvanized and powder coated for outdoor use, yellow (like RAL 1023), with black warning stripe, base plate 150 x 100 x 6 mm, floor mounting via 4 drill holes à Ø 10 mm.

Art. No.	Description	Weight
E-SG	End post 1000 x 250 mm	5,4 kg
W-SG	Corner post 1000 x 500 / 250 mm	7,4 kg
M-SG	Middle post 1000 x 500	7,2 kg
FIX4	Floor anchor 85 mm galvanized set of 4 pieces	

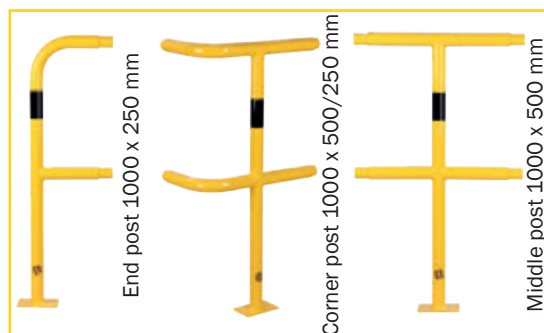

Modular corner post for safety barrier, Ø 60 mm, height 1.000 mm, 270° rotatable, 2,9 mm material thickness, galvanized and powder coated for outdoor use, yellow (like RAL 1023) with black warning stripe, base plate 150 x 100 x 6 mm, floor mounting via 4 drill holes à Ø 10 mm.

Art. No.	Description	Base plate	Weight
VE-SG	Modular corner post 1000 x 250 x 250 mm	150 x 100 x 6 mm	12,5 kg
FIX4	Floor anchor 85 mm galvanized set of 4 pieces		

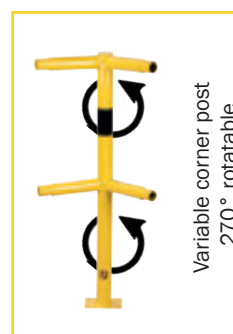

Beam for safety barrier, Ø 48,3 mm, 2,9 mm material thickness, galvanized and powder coated for outdoor use, yellow (like RAL 1023) with black warning stripe.

Art. No.	Description	Weight
RH-SG 50	Beam 500 mm	1,6 kg
RH-SG 100	Beam 1000 mm	3,2 kg
RH-SG 150	Beam 1500 mm	4,8 kg

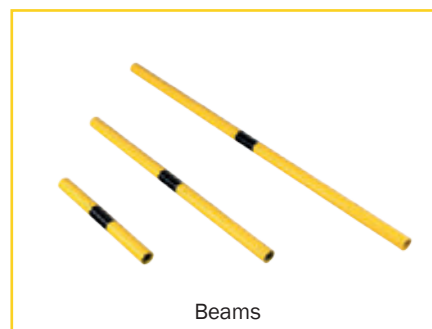



other RAL colors available



Customized versions possible!



Steel

## EXPANDING BARRIERS

Our TÜV-certified expanding barriers are made of steel and perfect for quickly closing off dangerous areas. Available colors: red-white version with double side reflecting foil and yellow black.

The expanding barriers allow space-saving storage. They are available in versions with feet, wheels, or wall bracket.

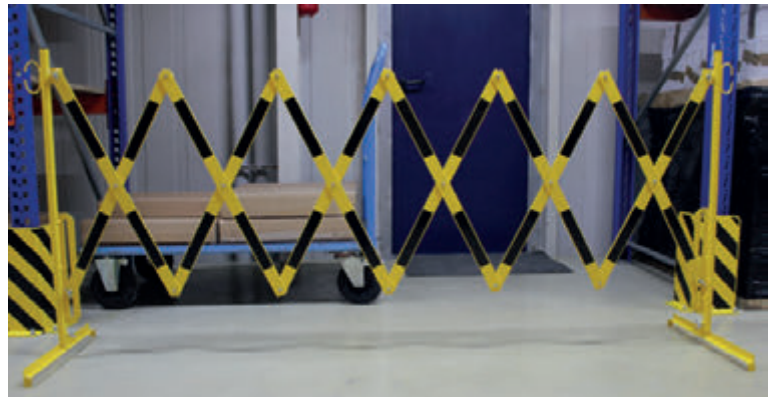
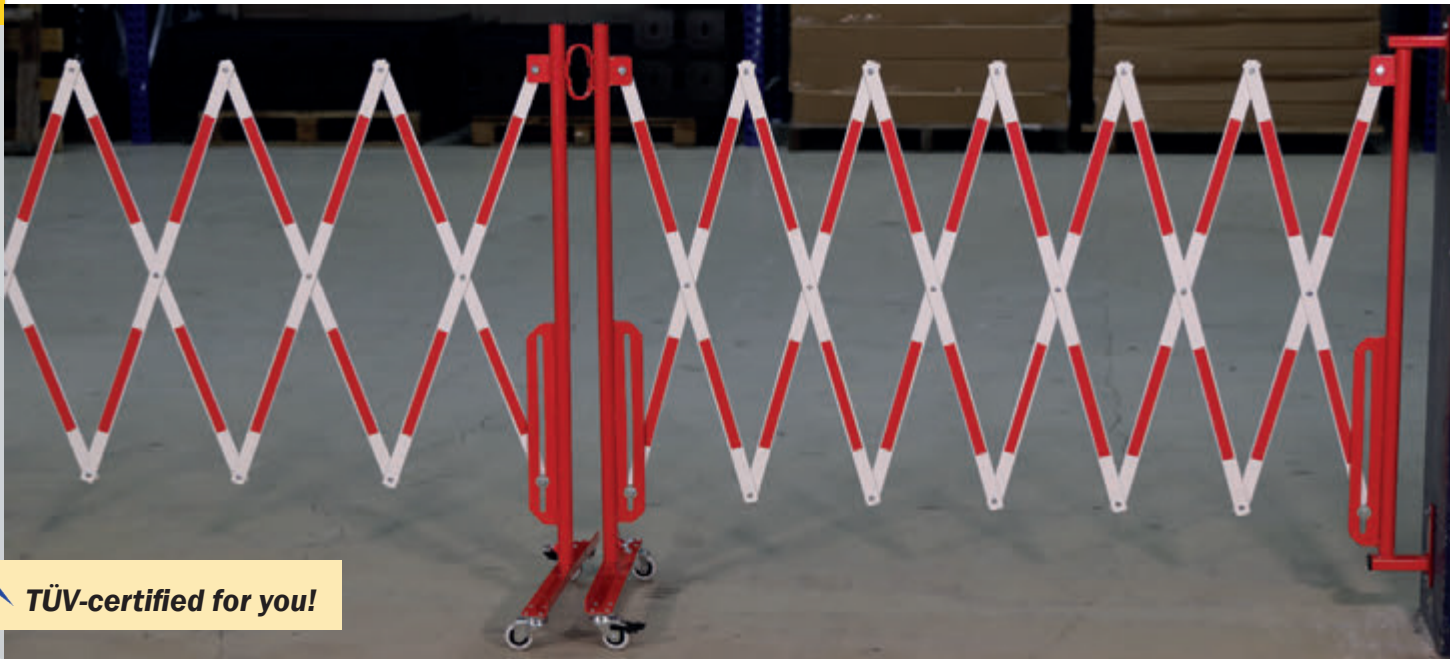

Photo: Art. No. 70-40



**TÜV-certified for you!**

Expandable to 3,6 m oder 4,0 m

Photo: Art. No. 70-10W

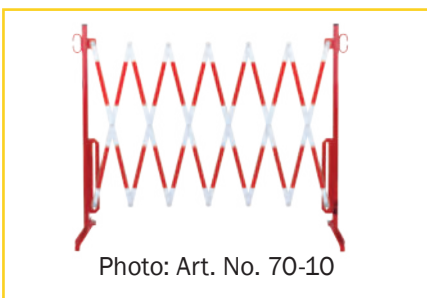

Photo: Art. No. 70-10

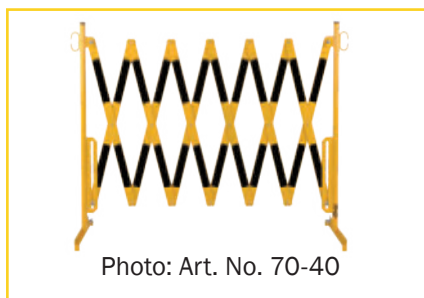

Photo: Art. No. 70-40

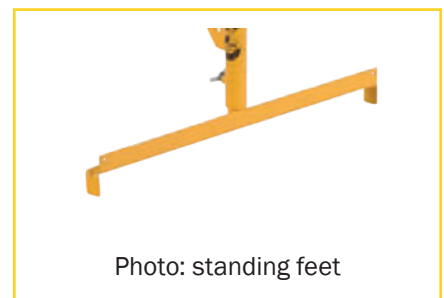

Photo: standing feet

**Expanding barriers, steel, height 1.050 mm, with feet on both sides, powder coated for indoor use, red-white version with reflecting foil on both sides, TÜV-certified.**

Art. No.	Width	Color	Folded width total	Material flat steel	Weight
70-10	3600 mm	red-white	ca. 335 mm	4 x 25 mm	13,1 kg
70-20	4000 mm	red-white	ca. 430 mm	5 x 40 mm	20,3 kg
70-30	3600 mm	yellow-black	ca. 335 mm	4 x 25 mm	13,1 kg
70-40	4000 mm	yellow-black	ca. 430 mm	5 x 40 mm	21,1 kg



other RAL colors available

5 Customized versions possible!



TÜV-certified for you!

## Steel EXPANDING BARRIERS WITH CASTERS

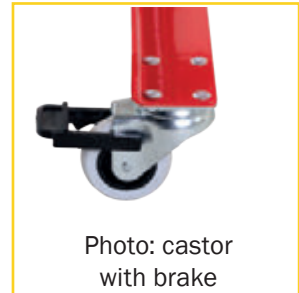
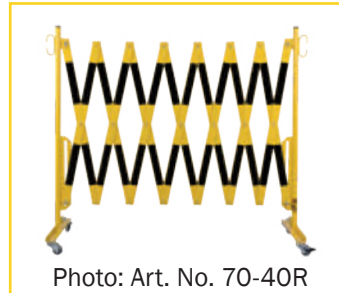
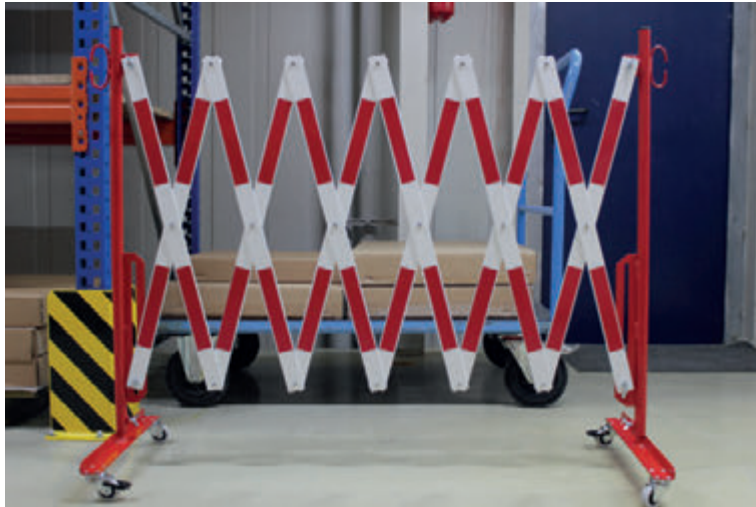

Expanding barriers, steel, height 1.050 mm, with casters on both sides, powder coated for indoor use, red-white version with reflecting foil on both sides, TÜV-certified.

Art. No.	Width	Color	Folded width total	Castors	Material flat steel	Weight
70-10R	3600 mm	red-white	ca. 335 mm	yes	4 x 25 mm	14,6 kg
70-20R	4000 mm	red-white	ca. 430 mm	yes	5 x 40 mm	22,2 kg
70-30R	3600 mm	yellow-black	ca. 335 mm	yes	4 x 25 mm	14,6 kg
70-40R	4000 mm	yellow-black	ca. 430 mm	yes	5 x 40 mm	22,2 kg

## EXPANDING BARRIER WITH CASTERS AND WALL BRACKET

Expanding barriers, steel, height 1.050 mm, with castors on one side and wall bracket on the other, powder coated for indoor use, red-white version with reflecting foil on both sides, TÜV-certified.

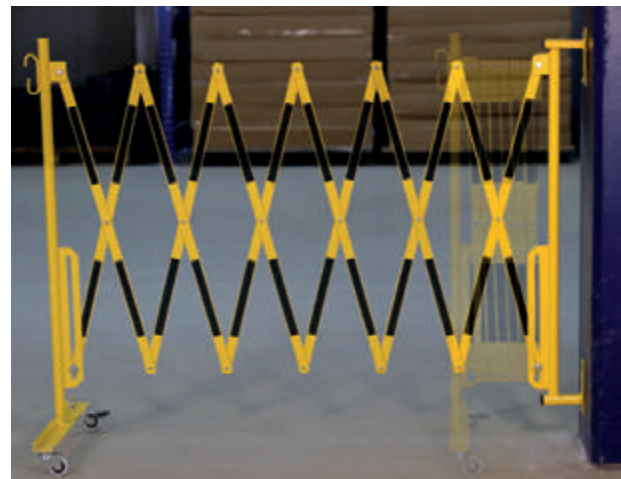
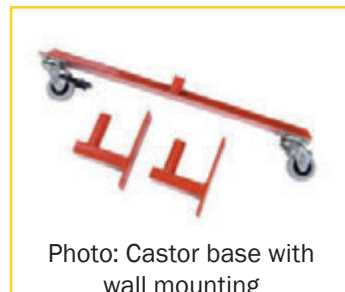
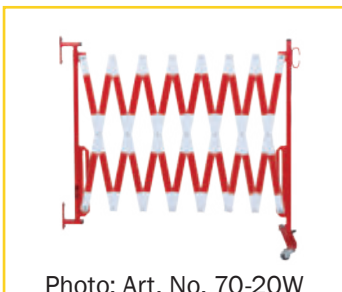

Art. No.	Width	Color	Folded width total	Castors	Material flat steel	Weight
70-10W	3600 mm	red-white	ca. 300 mm	yes	4 x 25 mm	14,3 kg
70-20W	4000 mm	red-white	ca. 390 mm	yes	5 x 40 mm	21,6 kg
70-30W	3600 mm	yellow-black	ca. 300 mm	yes	4 x 25 mm	14,3 kg
70-40W	4000 mm	yellow-black	ca. 390 mm	yes	5 x 40 mm	21,6 kg



other RAL colors available



Customized versions possible!



Steel

## EXPANDING BARRIER WITH POST

The steel post version can be positioned in areas where the wall bracket is not an option.

Like the TÜV-certified expanding barriers with wall bracket, these sets are available in yellow-black and red-white in standard lengths of 3.6 m and 4.0 m. The steel barrier posts are available with rectangular posts 70 x 70 mm or round posts  $\varnothing$  60 mm. For temporary use, the round barrier post can also be combined with a mobile base plate.



Photo: Art. No. 70-100

**Expanding Barrier with post and casters, steel, height 1.050 mm, powder coated for indoor use, base plate 195 x 120 mm, floor mounting via 4 drill holes à  $\varnothing$  12,5 mm, TÜV-certified.**

Art. No.	Post	Color	Expanding barrier	Width	Folded width total	Weight
70-55	$\varnothing$ 60 mm	red-white	Flat steel 25 x 4 mm	3600 mm	ca. 400 mm	17,4 kg
70-60	$\varnothing$ 60 mm	red-white	Flat steel 40 x 5 mm	4000 mm	ca. 490 mm	24,0 kg
70-65	$\varnothing$ 60 mm	yellow-black	Flat steel 25 x 4 mm	3600 mm	ca. 400 mm	17,4 kg
70-70	$\varnothing$ 60 mm	yellow-black	Flat steel 40 x 5 mm	4000 mm	ca. 490 mm	24,0 kg
70-95	70 x 70 mm	red-white	Flat steel 25 x 4 mm	3600 mm	ca. 410 mm	17,4 kg
70-100	70 x 70 mm	red-white	Flat steel 40 x 5 mm	4000 mm	ca. 500 mm	24,4 kg
70-105	70 x 70 mm	yellow-black	Flat steel 25 x 4 mm	3600 mm	ca. 410 mm	17,4 kg
70-110	70 x 70 mm	yellow-black	Flat steel 40 x 5 mm	4000 mm	ca. 500 mm	24,4 kg

Steel

## EXPANDING BARRIER WITH HEAVY FOOT PLATE

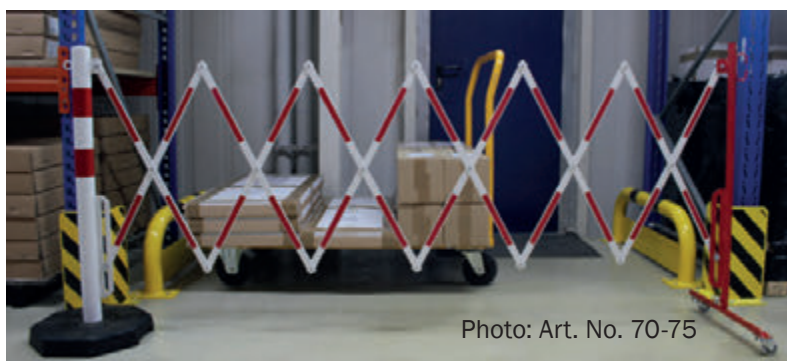

Photo: Art. No. 70-75



Photo: Art. No. 70-90

**Expanding Barrier with heavy foot plate and casters, steel, height 1.050 mm, powder coated for indoor use, mobile foot plate for posts  $\varnothing$  60 mm, TÜV-certified.**

Art. No.	Post	Color	Expanding barrier	Width	Folded width total	Weight
70-75	$\varnothing$ 60 mm	red-white	Flat steel 25 x 4 mm	3600 mm	ca. 490 mm	22,7 kg
70-80	$\varnothing$ 60 mm	red-white	Flat steel 40 x 5 mm	4000 mm	ca. 620 mm	30,0 kg
70-85	$\varnothing$ 60 mm	yellow-black	Flat steel 25 x 4 mm	3600 mm	ca. 490 mm	22,7 kg
70-90	$\varnothing$ 60 mm	yellow-black	Flat steel 40 x 5 mm	4000 mm	ca. 620 mm	30,0 kg





other RAL colors available



Customized versions possible!



Steel

## EXPANDING BARRIER SETS

These massive expanding barrier sets in lengths of 4 m or 16 m provide high stability without the need for floor mounting. The TÜV-certified expanding barriers can be used to temporarily close off access points and areas.

They are easily handled due to ball bearings, handles and self-locking nuts. The individual elements can be connected via a retaining rod; besides, an information board can be added.

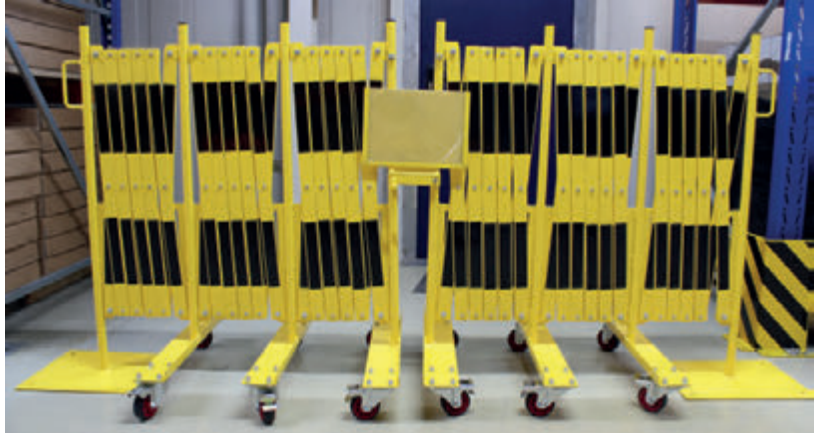

Photo: Art. No. 70-130



Photo: Art. No. 70-115

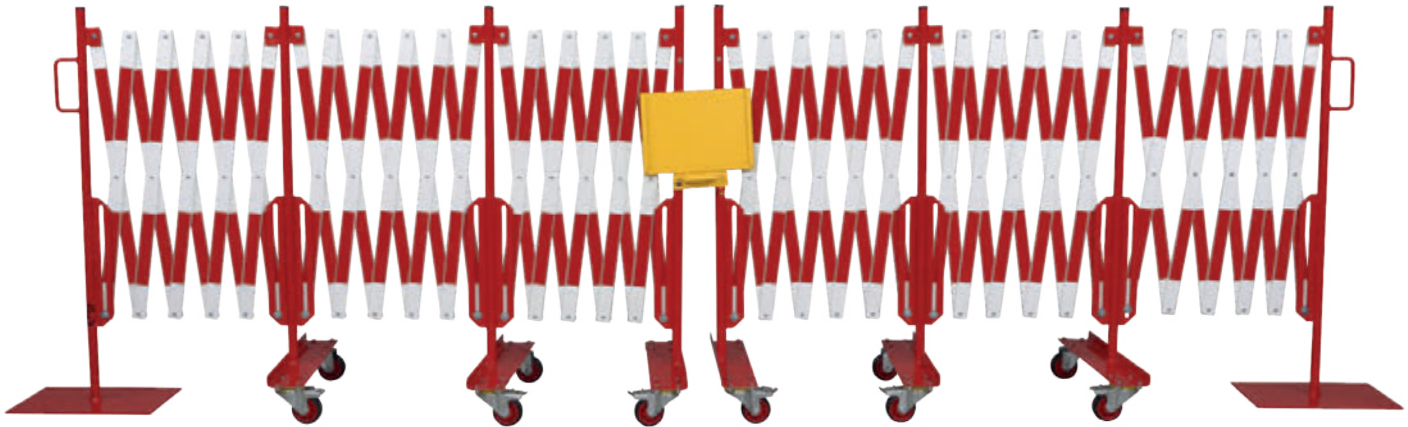

Photo: Art. No. 70-120

**Expanding Barrier Set HEAVY DUTY, steel, height 1.050 mm, galvanized and powder coated for outdoor use, base plates 400 x 300 x 6 mm, heavy duty casters with brakes, side handles, retaining rod, steel document holder, TÜV-certified.**

Art. No.	Description	Folded width total	Weight
70-115	Expanding barrier, 2 x 2000 mm, galvanized and powder coated, red-white	ca. 1160 mm	54,0 kg
70-125	Expanding barrier, 2 x 2000 mm, galvanized and powder coated, yellow-black	ca. 1160 mm	54,0 kg
70-120	Expanding barrier, 2 x 8000 mm, galvanized and powder coated, red-white	ca. 2340 mm	128,0 kg
70-130	Expanding barrier, 2 x 8000 mm, galvanized and powder coated, yellow-black	ca. 2340 mm	128,0 kg





other RAL colors available



Customized versions possible!



Steel

## EXPANDING BARRIER KIT

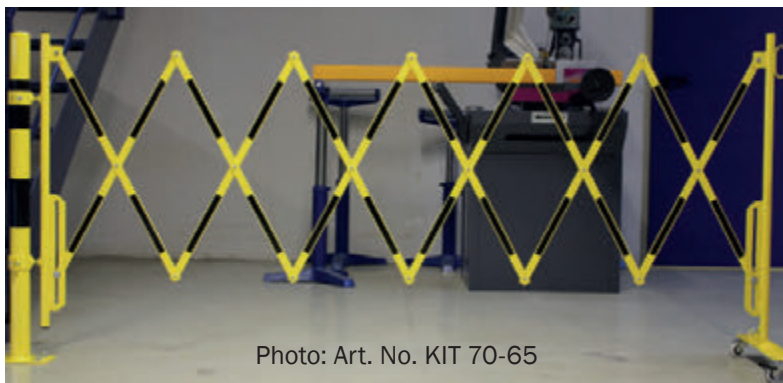

Photo: Art. No. KIT 70-65



Photo: Art. No. KIT 70-100

Expanding barrier kit with fixing bracket for mounting on already existing posts, delivery excl. post, expanding barrier with casters and brake, height 1.050 mm, TÜV-certified

Art. No.	Post	Color	Expanding barrier	Width	Folded width total	Weight
KIT 70-55	ø 60 mm	red-white	Flat steel 25 x 4 mm	3600 mm	ca. 335 mm	14,4 kg
KIT 70-60	ø 60 mm	red-white	Flat steel 40 x 5 mm	4000 mm	ca. 430 mm	21,9 kg
KIT 70-65	ø 60 mm	yellow-black	Flat steel 25 x 4 mm	3600 mm	ca. 335 mm	14,4 kg
KIT 70-70	ø 60 mm	yellow-black	Flat steel 40 x 5 mm	4000 mm	ca. 430 mm	21,9 kg
KIT 70-95	70 x 70 mm	red-white	Flat steel 25 x 4 mm	3600 mm	ca. 345 mm	14,4 kg
KIT 70-100	70 x 70 mm	red-white	Flat steel 40 x 5 mm	4000 mm	ca. 440 mm	22,1 kg
KIT 70-105	70 x 70 mm	yellow-black	Flat steel 25 x 4 mm	3600 mm	ca. 345 mm	14,4 kg
KIT 70-110	70 x 70 mm	yellow-black	Flat steel 40 x 5 mm	4000 mm	ca. 440 mm	22,1 kg



**TÜV-certified for you!**

Expanding barrier kit yellow-black (for mounting on already existing posts 100 x 100 mm, safety barrier), expanding barrier with casters and brake, height 1.050 mm, TÜV-certified.

Art. No.	Expanding barrier	Width	Folded width total	Weight
KIT SG 70-30	Flat steel 25 x 4 mm	3600 mm	ca. 335 mm	15,1 kg
KIT SG 70-40	Flat steel 40 x 5 mm	4000 mm	ca. 430 mm	22,1 kg



Photos: fixing bracket

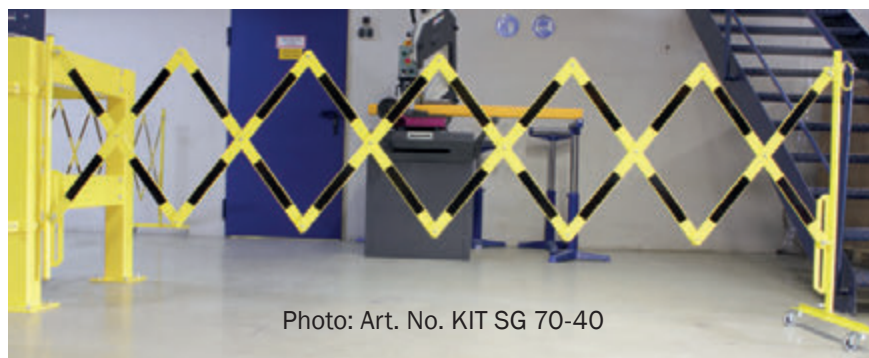

Photo: Art. No. KIT SG 70-40

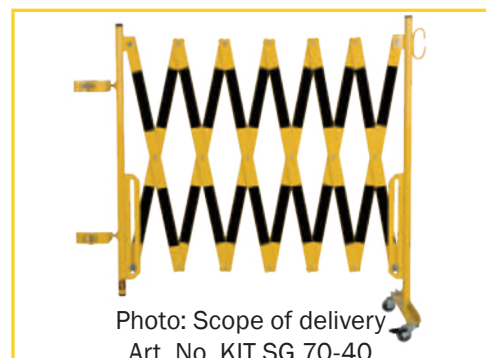

Photo: Scope of delivery Art. No. KIT SG 70-40



Steel

## EXPANDING BARRIER TROLLEY

The expanding barrier trolley is the best solution for temporary shutoffs during installations, maintenance, or clean-up operations. The trolley with integrated tool holder enables a fast use of the expanding barrier. The expanding barriers can be extended to a length of 2.000 mm and rotated by 180° so there is an appropriate solution for every local condition.

The base plate of the trolley provides a safe stand and casters ensure easy maneuvering. The optional information board (art. no. ITSW-40-30) generates a plus of awareness.



other RAL colors available



Customized versions possible!



TÜV-certified for you!

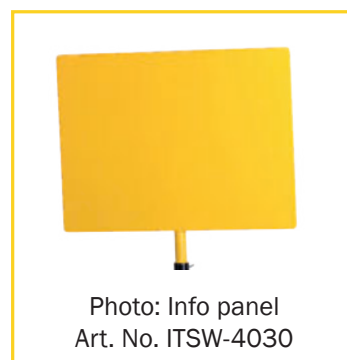

Art. No.	Description	Weight
70-150	Expanding barrier trolley with casters and toolbox, steel, powder coated for indoor use, yellow (like RAL 1023) with black warning stripes, two 2.000 mm barriers, swivel in 180° radius, base plate 300 x 200 x 70 mm, TÜV-certified	40,0 kg
<b>Following article not TÜV-tested yet</b>		
ITSW-4030	Info panel, yellow, height 300 mm, width 400 mm	2,0 kg

Photo: easy handling, the trolley is tiltable and mobile





other RAL colors available



Customized versions possible!



Steel

## IMPACT PROTECTION STEEL

The steel impact protection products are made of high-grade steel and facilitate the effective protection of inventory, machines, and buildings both outdoors and indoors. Hazardous areas are clearly marked due to the combination of yellow coating and black warning stripes.

Beams and hoop guards are available in Ø 76 mm. The hoop guards are formed using the latest bending technology therefore there are no weld seams!

The bollards are available in Ø 76 mm, 88.9 mm, and 159 mm.

The product is fixed via floor anchors which are available separately.

The hoop guards with anderride protection are a perfect addition for sensitive areas that require special protection. They are available in a variety of types and measures to facilitate finding the right product.



**TÜV-certified for you!**



**Hoop protection guard, Ø 76 mm, galvanized and powder coated for outdoor use or powder coated for indoor use, yellow (like RAL 1023) with black warning stripes, material thickness 3,2 mm, base plate 120 x 195 mm, floor mounting via 8 drill holes à Ø 12,5 mm, TÜV-certified.**



Art. No. powder coated	Art. No. galvanized and powder coated	Height	Width	Weight
30-10-	30-10	350 mm	420 mm	6,9 kg
30-20-	30-20	350 mm	750 mm	8,5 kg
30-30-	30-30	350 mm	1000 mm	10,1 kg
30-40-	30-40	600 mm	750 mm	11,5 kg
30-50-	30-50	600 mm	1000 mm	13,0 kg
30-60-	30-60	1200 mm	750 mm	18,5 kg
30-70-	30-70	1200 mm	1000 mm	20,0 kg

Floor anchor 85 mm galvanized set of 8 pieces Art. No. FIX8

**Hoop guard with anderride protection, Ø 76 mm, powder coated for indoor use, yellow (like RAL 1023) with black warning stripes, material thickness 3,2 mm, base plate 120 x 195 mm, floor mounting via 8 drill holes à Ø 12,5 mm, TÜV-certified.**



Art. No.	Height	Width	Height anderride guard	Weight
30-20-U	350 mm	750 mm	150 mm	11,4 kg
30-30-U	350 mm	1000 mm	150 mm	13,0 kg
30-40-U	600 mm	750 mm	400 mm	18,0 kg
30-50-U	600 mm	1000 mm	400 mm	24,1 kg

Floor anchor 85 mm galvanized set of 8 pieces Art. No. FIX8





**TÜV-certified for you!**



**Impact protection beam, Ø 76 mm, galvanized and powder coated for outdoor use, yellow (like RAL 1023) with black warning stripes, material thickness 3,2 mm, base plate 120 x 195 mm, floor mounting via 8 drill holes à Ø 12,5 mm, TÜV-certified.**

Art. No.	Description	Weight
60-10	Length 400 mm	4,3 kg
60-20	Length 800 mm	6,6 kg
60-30	Length 1200 mm	8,9 kg
FIX8	Floor anchor 85 mm galvanized set of 8 pieces	



**Impact protection bollard, galvanized and powder coated for outdoor use, yellow (like RAL 1023) with black warning stripes, base plate 120 x 195 mm, floor mounting via 4 drill holes à Ø 12,5 mm, TÜV-certified.**

Art. No.	Diameter	Base plate	Material thickness	Weight
50-10	Ø 76 mm	120 x 195 mm	3,2 mm	8,3 kg
50-25	Ø 89 mm	140 x 195 mm	3,6 mm	9,9 kg
50-40	Ø 159 mm	240 x 240 mm	4,5 mm	23,4 kg
FIX4	Floor anchor 85 mm galvanized set of 4 pieces			



Art. No.	Diameter	Concrete setting	Material thickness	Weight
50-20	Ø 76 mm	1200 mm	3,2 mm	9,4 kg
50-30	Ø 159 mm	1200 mm	4,5 mm	27,8 kg

**Impact corner protection, arms 600 mm, Ø 76 mm, material thickness 3,2mm, base plate 120 x 195 mm, floor mounting via 12 drill holes à Ø 12,5 mm, TÜV-certified.**

Art. No. powder coated	Art. No. galvanized and powder coated	Height	Weight
40-10-	40-10	350 mm	12,9 kg
40-20-	40-20	600 mm	17,5 kg
40-30-	40-30	1200 mm	27,9 kg
Floor anchor 85 mm galvanized Art. No. FIX1			
Floor anchor 85 mm galvanized set of 4 pieces Art. No. FIX4			



**Impact corner protection with anderride guard, height 1.000 mm, Ø 76 mm, material thickness 3,2 mm, base plate 120 x 195 mm, floor mounting via 12 drill holes à Ø 12,5 mm, TÜV-certified.**

Art. No. powder coated	Art. No. galvanized and powder coated	Arms	Height anderride guard	Weight
40-40-UW-	40-40-UW	300 mm	200 mm	16,8 kg
40-50-UW-	40-50-UW	600 mm	200 mm	28,7 kg
40-60-UW-	40-60-UW	900 mm	200 mm	40,0 kg
40-70-UW-	40-70-UW	1200 mm	200 mm	50,0 kg
Floor anchor 85 mm galvanized Art. No. FIX1				





other RAL colors available



Customized versions possible!



Steel

## MODULAR WALL PROTECTION

The modular wall protection system made of steel is the perfect solution to secure logistic areas. The different components meet the requirements of any local condition. Due to the variety of straight elements and in- or outside corners, endangered building sections are easily protected. Fixing material is available separately.

**Modular wall protection, straight, Ø 76 mm, height 140 mm, galvanized and powder coated for outdoor use or powder coated for indoor use, yellow (like RAL 1023), base plate 120 x 195 x 6 mm, floor mounting via 4 drill holes à Ø 12,5 mm, TÜV-certified.**

Art. No. powder coated	Art. No. galvanized and powder coated	Length	Width	Weight
80-500-	80-500	500 mm	180 mm	5,5 kg
80-1000-	80-1000	1000 mm	180 mm	10,4 kg

Floor anchor 85 mm galvanized set of 4 pieces Art. No. FIX4 / 1 piece Art. No. FIX1

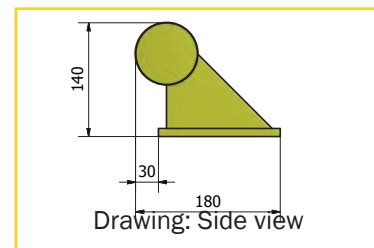

Photo: left inner corner protection

### Modular wall protection, inner corner

**Ø 76 mm, height 140 mm, galvanized and powder coated for outdoor use or powder coated for indoor use, yellow (like RAL 1023), base plate 120 x 195 x 6 mm, floor mounting via 4 drill holes à Ø 12,5 mm, TÜV-certified.**

Description	Corner 90° right, inside		Corner 90° left, inside	
	Lenght 500 mm Art. No.	Lenght 1000 mm Art. No.	Lenght 500 mm Art. No.	Lenght 1000 mm Art. No.
Powder coated	80-500WRI-	80-1000WRI-	80-500-WLI-	80-1000-WLI-
Galvanized and powder coated	80-500WRI	80-1000WRI	80-500-WLI	80-1000-WLI
Weight	5,6 kg	11,3 kg	5,6 kg	11,3 kg
Drawing				

### Modular wall protection, outer corner

**Ø 76 mm, height 140 mm, galvanized and powder coated for outdoor use or powder coated for indoor use, yellow (like RAL 1023), base plate 120 x 195 x 6 mm, floor mounting via 4 drill holes à Ø 12,5 mm, TÜV-certified**

Description	Corner 90° right, outside		Corner 90° left, outside	
	Lenght 500 mm Art. No.	Lenght 1000 mm Art. No.	Lenght 500 mm Art. No.	Lenght 1000 mm Art. No.
Powder coated	80-500WRA-	80-1000WRA-	80-500-WLA-	80-1000-WLI-
Galvanized and powder coated	80-500WRA	80-1000WRA	80-500-WLA	80-1000-WLA
Weight	5,4 kg	10,9 kg	5,4 kg	10,9 kg
Drawing				

 **TÜV-certified for you!**



Steel

## CRASH PROTECTION GUARD

The TÜV-certified CrashStop rack protectors are designed according to the German Berufsgenossenschaft regulation in the L-form. These are required at the corner supports of fixed racks in order to protect the racks from collisions. The articles are marked with a yellow / black warning mark and are dimensioned accordingly to legal requirements. Further variants, like the U-shape for the middle rack legs, complete the assortment with different heights. If required, these articles can also be produced according to special customer requirements.

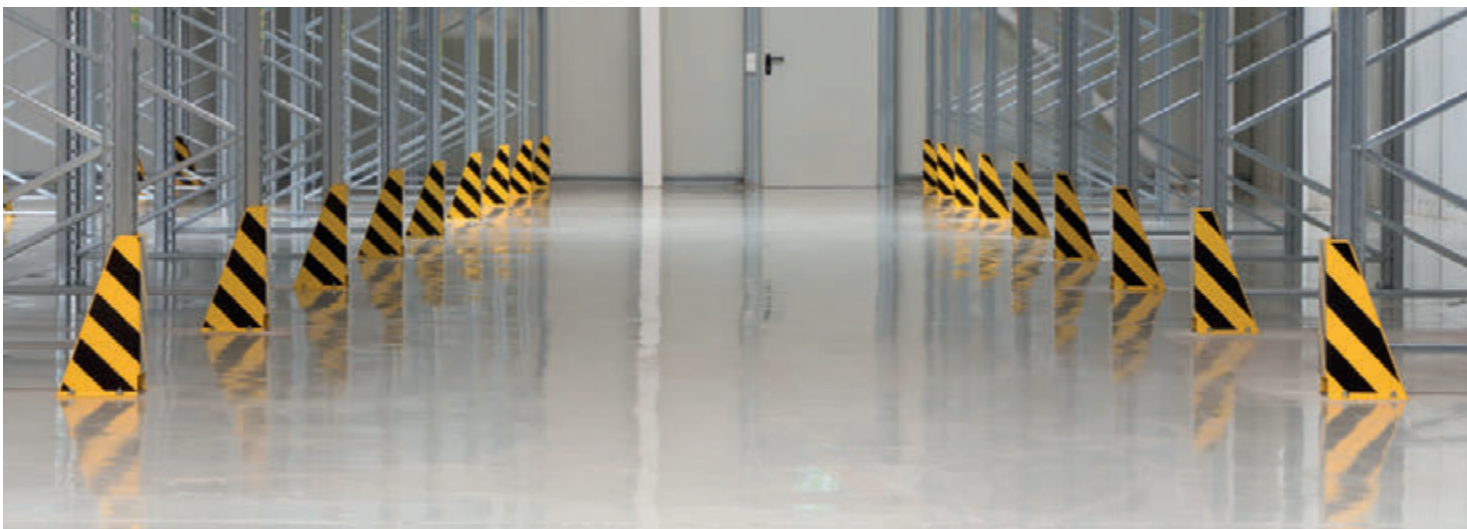

**other RAL colors available**



**Customized versions possible!**



**Crash protection guards, height 400 mm, material thickness 5 mm, powder coated for indoor use, yellow (like RAL 1023), with black warning stripes, floor mounting via 4 drill holes à Ø 15 mm, TÜV-certified.**

Art. No.	Description	Weight
6260	L-profile 180 x 180 mm	6,1 kg
6250	U-profile inside 125 mm	6,4 kg
6255	U-profile XL inside 160 mm	7,0 kg
FIX1	Ground anchor for collision protection	
FIX4	Floor anchor 85 mm galvanized set of 4 pieces Art. No. FIX4	



**Special sizes possible from 1 piece!**







other RAL colors available



Customized versions possible!



Steel

## MODULAR RACK END PROTECTION

The modular rack end protection is a useful product to protect the end parts of racks. The left- and right sided modules protect the rack leg and, together with the side modules, enable a full protection of the rack ends. The hoop guard comes with rounded edges.



**Modular rack end protection, powder coated for indoor use, yellow (like RAL 1023) with black warning stripes, for floor mounting, TÜV-certified**

Art. No.	Description	Length	Height	Width	Weight
ME-SET-L	Set left	1230 mm	400/200 mm	280 mm	19,3 kg
ME-SET-R	Set right	1230 mm	400/200 mm	280 mm	19,3 kg
ME-F-R	Teil A right	230 mm	400 mm	300 mm	8,8 kg
ME-F-L	Teil A left	230 mm	400 mm	300 mm	8,8 kg
ME-V-R	Additional part B right	500 mm	200 mm		5,4 kg
ME-V-L	Additional part B left	500 mm	200 mm		5,4 kg



**TÜV-certified for you!**

Photo: Art. No. ME-SET-L

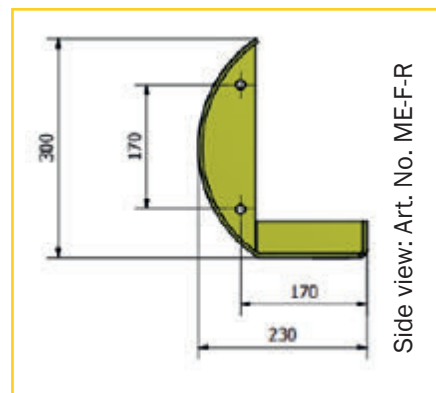

Side view: Art. No. ME-F-R



Photo: Art. No. ME-F-L



Photo: view of the connection



Photo: Art. No. ME-F-R



Photo: Art. No. ME-V-R



other RAL colors available



Customized versions possible!



Steel

## HEIGHT-ADJUSTABLE GUARDRAIL

The height-adjustable guardrail is a special protection against damages in areas with slopes. The guardrail is adjustable by 130 mm on a length of 2.400 mm. The height adjustment is accomplished via levelling screws and adjustable base plates.



The fixing material is available separately.

**Height-adjustable guard rail, length 2.400 mm, adjustable height 386-516 mm, plank height 300 mm, galvanized and powder coated for outdoor use, yellow (like RAL 1023) with black warning stripes, for floor mounting, TÜV-certified.**

Art. No.	Description	Weight
HVA-2400	height-adjustable guard-rail, length 2.400 mm, plank height 300 mm, total height 386-516 mm	48,0 kg
FIX8	Floor anchor 85 mm galvanized set of 8 pieces	



**Foot plate adjustable**

Steel

## IMPACT PROTECTION FOR LONG PALLETS

The impact protection for long pallets is the best solution for protecting goods which protrude into pathways. It is easily employed without any additional mounting. The impact protection is fixed by the weight of the pallet and easily removed. The yellow-black warning colors ensure high visibility.

**Impact protection for long pallets, 860 x 400 mm, cut-out size 620 x 300 mm, powder coated for indoor use, yellow (like RAL 1023), with black warning stripes**

Art. No.	Description	Weight
6270	Impact protection for long pallets, width 860 mm, arm length 200 mm, height 400 mm, cut-out 620 x 300 mm	14,0 kg

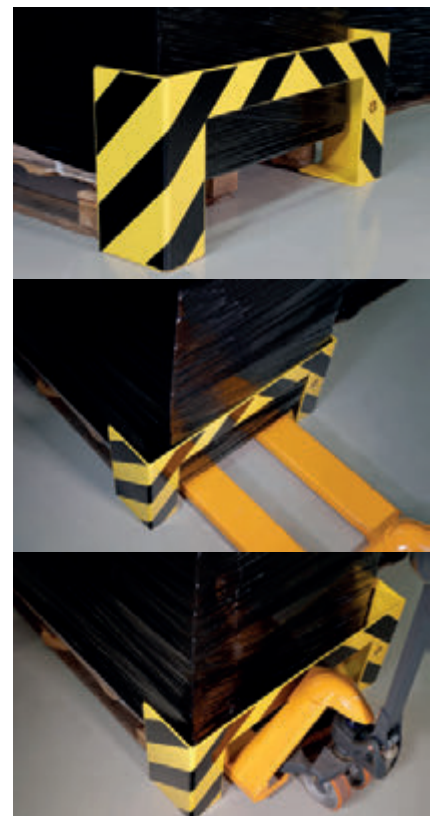

other RAL colors available



**No floor mounting**



Polyethylene

## COLUMN PROTECTION

Our column protection is a safeguard for posts and columns. Without any tools or floor mounting, the column protection can be installed by one person within seconds using reinforced velcro fasteners. The column protection is suitable for indoor and outdoor use. The Column protectors

30110, 30120 and 30130 come with reflective warning stripes. The velcro fasteners are included in the delivery.

### Column protection made of polyethylene, height 1.000 mm

Art. No.	For columns	Outer size	Weight
30140	100 x 100 mm	435 x 390 mm	14,0 kg
30150	150 x 150 mm	435 x 390 mm	14,0 kg

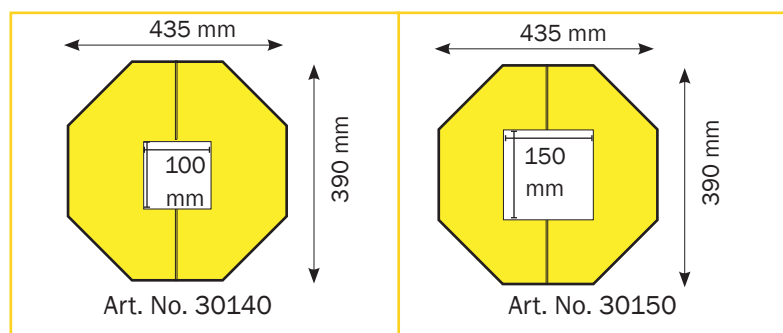

Photo: Art. No. 30150

### Column protection made of polyethylene, height 1.100 mm, with two retro-reflecting warning stripes

Art. No.	For columns	Diameter	Weight
30110	160 x 160 mm	ø 620 mm	20,5 kg
30120	210 x 210 mm	ø 620 mm	17,0 kg
30130	260 x 260 mm	ø 620 mm	17,0 kg



**with red-white warning marks**



Photo: Art. No. 30110

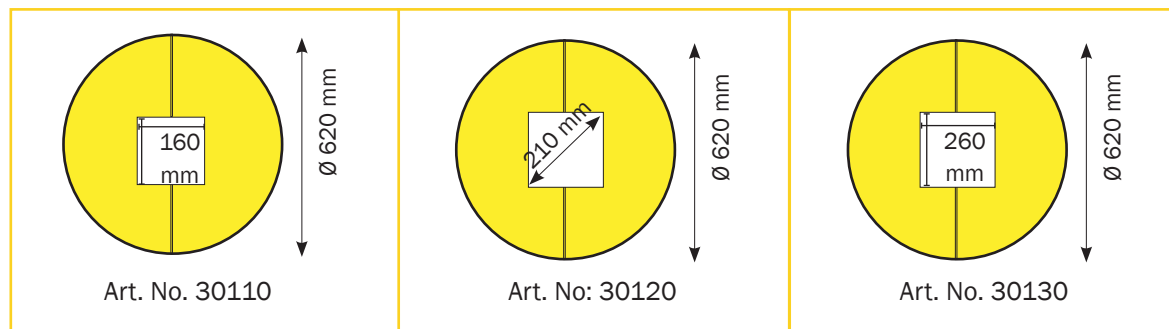





Polyethylene

## MODULAR COLUMN PROTECTION

The modular column protector is an effective solution to protect posts both in- and outside. It is made of shock-resistant polyethylene and suitable for columns with side lengths of 200-700 mm. It can be cut to size as per requirement. Floor mounting is not required, so the protector is easily removed without any residue. The installation can be carried out by one person.

### Column protection made of polyethylene, 1.000 mm

Art. No.	Description	For columns	Height	Weight
30610	Column protection	200 - 700 mm	1000 mm	20,0 kg



Photo: Cutting marks in mm

Photo: Art. No. 30610

Steel

## COLUMN PROTECTION

The steel column protection consists of parts of the TÜV-certified safety barrier and ensures the protection of columns of max. 60 x 60 cm.

The set consists of 4 corner posts with a height of 1.000 mm and 8 beams (beam fixing material included). The fixing material for floor mounting is available separately. The yellow coloring ensures good visibility and reduces accidents.

 other RAL colors available



Customized versions possible!



Heavy duty column protection, height 1.000 mm, powder coated for indoor use, yellow (like RAL 1023), set contains 4 corner posts 1.000 x 100 x 100 mm, base plate 200 x 200 mm, floor mounting via 4 drill holes à Ø 12,5 mm, 8 beams, including beam fixing material, TÜV-certified.

Art. No.	Diameter	Weight
SSG-50	For columns max. 40 x 40 cm	114,0 kg
SSG-75	For columns max. 60 x 60 cm	142,0 kg
FIX4	Floor anchors 85 mm galvanized set of 4 pieces	
FIX8	Floor anchors 85 mm galvanized set of 8 pieces	



**TÜV-certified for you!**

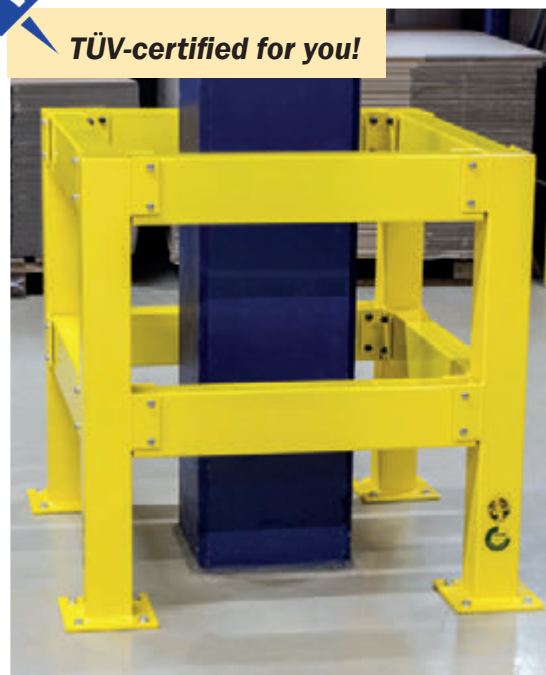

Photo: Art. No. SSG-75



other RAL colors available



Customized versions possible!



Steel

## STEEL POST PROTECTION

The post protector is a perfect solution for posts of up to 400 x 400 mm both in- and outdoors. The yellow-black warning stripes increase the visibility. The product is installed via base plates.

**Post and column protection, for posts of 400 x 400 mm max., 2 parts à 600 x 520 mm, galvanized and powder coated for outdoor use or powder coated for indoor use, yellow (like RAL 1023), base plate 160 x 70 mm, floor mounting via 8 drill holes à Ø 12,5 mm, TÜV-certified.**

Art. No. powder coated	Art. No. galvanized and powder coated	Height	Width	Weight
SRR-500-	SRR-500	600 mm	520 mm	16,6 kg
Floor anchors 85 mm galvanized set of 8 pieces Art. No. FIX8				

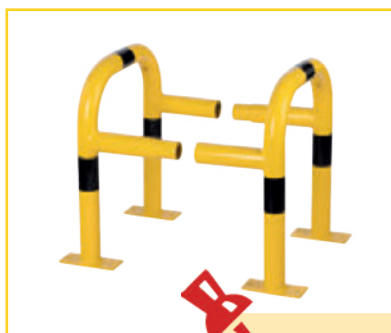

**consists of two parts**



**TÜV-certified for you!**

Steel

## CRASH PROTECTION GUARD FOR PIPES AND CABLES

These protective elements ensure solid protection for pipes of up to Ø 200 mm indoors and outdoors. The different measures combined with the yellow-black warning colors gives the perfect solution for protecting pipes and help reduce maintenance.



**TÜV-certified for you!**

**Protection for pipes and cables up to Ø 200 mm, 300 x 230 mm (inside width 290 mm), galvanized and powder coated for outdoor use, yellow (like RAL 1023) with black warning stripes, wall mounting, TÜV-certified.**



Art. No. powder coated	Art. No. galvanized and powder coated	Height	Inside width	Depth	Flap	Weight
RS-500-	RS-500	500 mm	290 mm	230 mm	50 mm	9,1 kg
RS-1000-	RS-1000	1000 mm	290 mm	230 mm	50 mm	18,3 kg

## STORAGE AND TRANSPORT RACK

The storage and transport rack for impact posts offers a fast and comfortable way to secure and mark large areas with light or coarse grounds. The storage and transport rack is easily moved and includes 40 white plastic posts for light substrates or 40 red metal barrier posts for tougher ground. The retainer on the rear side allows for a fast connection of the posts via red-white barrier tape (500 m roll). Afterwards, the individual parts can quickly be collected and stored.

Art. No.	Description	Weight
EPS-TG-EW	Storage and transport rack, incl. 40 white posts, height 1.270 mm, for soft ground, incl. 500 m shut-off tape (red-white, width 80 mm)	28,6 kg
EPS-TG-AMD	Storage and transport rack, incl. 40 shut-off rods with double loop, height 1.070 mm, for rough ground, incl. 500 m shut-off tape (red-white, width 80 mm)	63,0 kg
KEP-W	Chain post, plastic, white, Ø 40 mm with impact point, height 1.270 mm	0,5 kg
AMD1200	Shut-off rod, steel, red, height 1.200 mm	1,2 kg
ASB-RW	Shut-off tape 500 m, red-white, width 80 mm	1,3 kg



Photo: Art. No. EPS-TG-AMD

Photo: Art. No. EPS-TG-EW

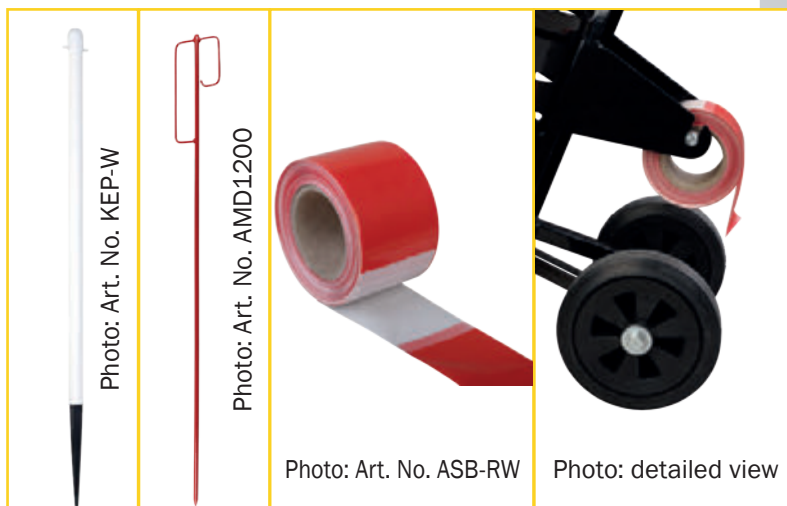

Photo: Art. No. KEP-W

Photo: Art. No. AMD1200

Photo: Art. No. ASB-RW

Photo: detailed view





other RAL colors available



Customized versions possible!



Steel

## BARRIER POST AND ACCESSORIES

The barrier posts and sets of chain posts are the most effective solution to mark hazardous areas in- and outdoors. The different versions, Ø 60 mm or 70 x 70 mm, enable a wide range of applications. Barrier posts for floor mounting, concrete setting or ground sleeves are available in yellow-black and red-white. The fixing material is available separately.

### BARRIER POSTS WITH EYELETS



TÜV-certified for you!

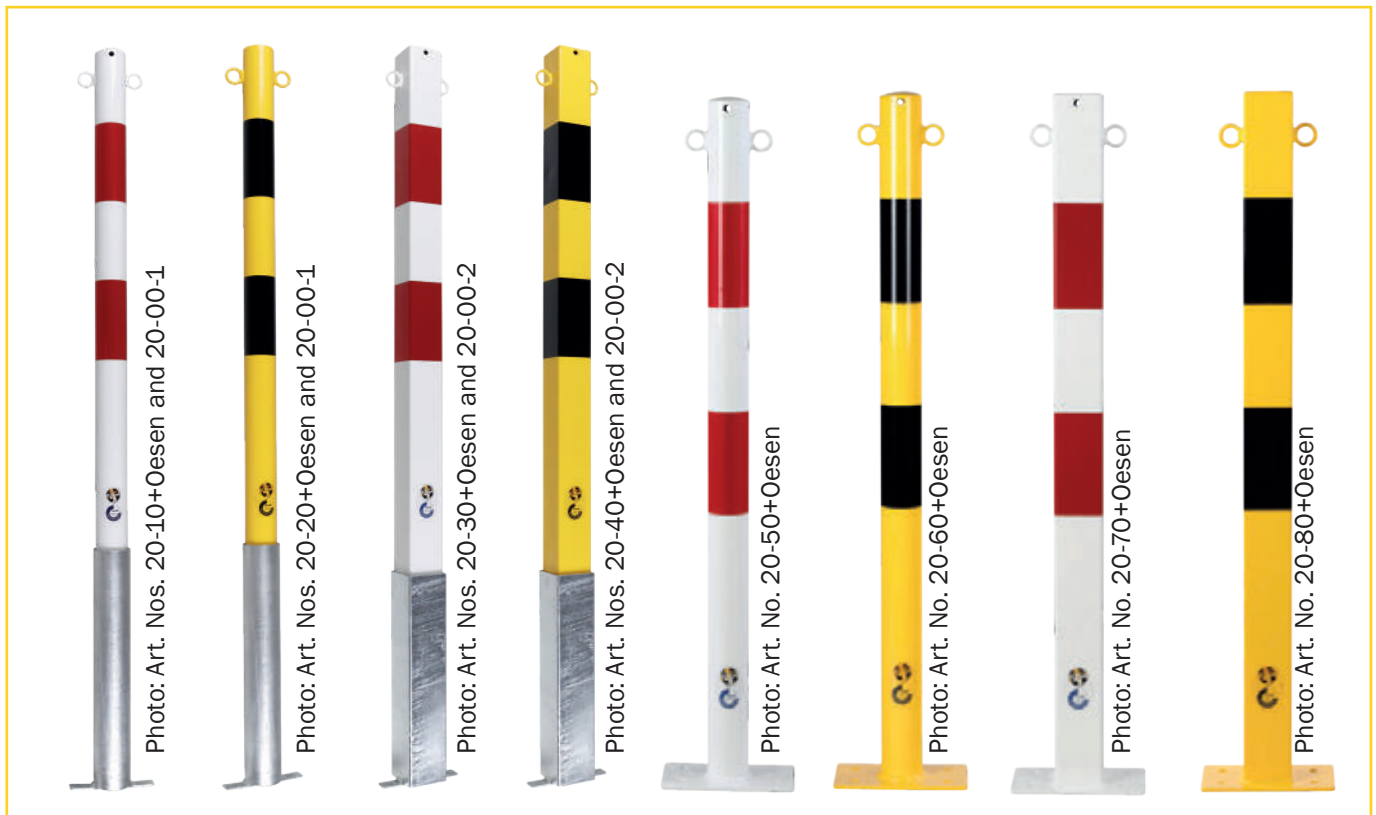

Art. No.	Description	Weight
<b>Post with eyelets to set in concrete, steel, galvanized and powder coated, height 1.400 mm, with ground sleeve, white post with red reflecting foil, TÜV-certified</b>		
20-10+Oesen and 20-00-1	Round post with eyelets, red-white Ø 60 mm and ground sleeve	8,4 kg
20-20+Oesen and 20-00-1	Round post with eyelets, yellow-black Ø 60 mm and ground sleeve	8,4 kg
20-30+Oesen and 20-00-2	Square post with eyelets, red-white, 70 x 70 mm and ground sleeve	9,2 kg
20-40+Oesen and 20-00-2	Square post with eyelets, yellow-black, 70 x 70 mm and ground sleeve	9,2 kg
<b>Post with eyelets, steel, galvanized and powder coated, height 1.000 mm, white post with red reflecting foil, base plate 120 x 195 mm, floor mounting via 4 drill holes à Ø 12,5 mm, TÜV-certified</b>		
20-50+Oesen	Round post with eyelets, red-white, Ø 60 mm	5,1 kg
20-60+Oesen	Round post with eyelets, yellow-black, Ø 60 mm	5,3 kg
20-70+Oesen	Square post with eyelets, red-white, 70 x 70 mm	5,6 kg
20-80+Oesen	Square post with eyelets, yellow-black, 70 x 70 mm	5,6 kg
FIX4	Floor anchors 85 mm galvanized set of 4 pieces	



# Steel BARRIER POSTS

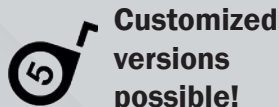
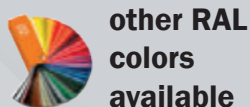

**TÜV-certified for you!**



Art. No.	Description	Weight
<b>Post to set in concrete, galvanized and powder coated, steel, height 1.400 mm, with ground sleeve, white post with red reflecting foil, TÜV-certified</b>		
20-10 and 20-00-1	Round post, red-white Ø 60 mm and ground sleeve	8,4 kg
20-20 and 20-00-1	Round post yellow-black Ø 60 mm and ground sleeve	8,4 kg
20-30 and 20-00-2	Square post, red-white, 70 x 70 mm and ground sleeve	9,1 kg
20-40 and 20-00-2	Square post, yellow-black, 70 x 70 mm and ground sleeve	9,1 kg
<b>Post, steel, galvanized and powder coated, height 1.000 mm, white post with red reflecting foil, base plate 120 x 195 mm, floor mounting via 4 drill holes à Ø 12,5 mm, TÜV-certified</b>		
20-50	Round post, red-white, Ø 60 mm	5,2 kg
20-60	Round post, yellow-black, Ø 60 mm	5,2 kg
20-70	Square post, red-white, 70 x 70 mm	5,5 kg
20-80	Square post, yellow-black, 70 x 70 mm	5,5 kg
FIX4	Floor anchors 85 mm galvanized set of 4 pieces	



Steel

## BARRIER POSTS AND ACCESSORIES



other RAL colors available



Customized versions possible!



Art. No.	Description	Weight
<b>Road barrier posts with eyelets and mobile base plate, total height 1000 mm</b>		
10-10-1 and MPF	Road barrier post, with eyelets, yellow-black, Ø 60 mm, height 1000 mm and mobile base plate	10,5 kg
10-20-1 and MPF	Road barrier post, with eyelets, red-white, Ø 60 mm, height 1000 mm and mobile base plate	10,5 kg
<b>Road barrier posts with eyelets and knock-in ground socket in set, height above floor 1000 mm, total height 1500 mm</b>		
10-10	Barrier post yellow-black and impact ground sleeve	8,6 kg
10-20	Barrier post red-white reflective and impact ground sleeve	8,6 kg





# Steel BARRIER POSTS AND ACCESSORIES



other RAL  
colors  
available



Customized  
versions  
possible!

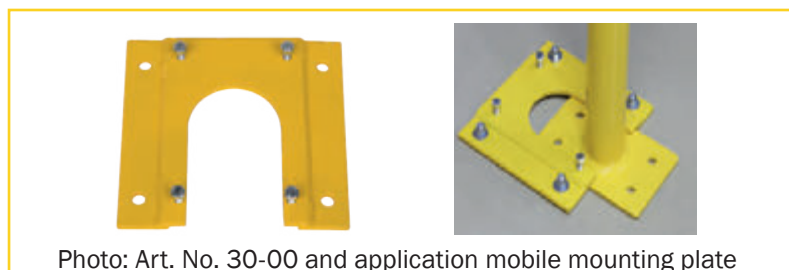
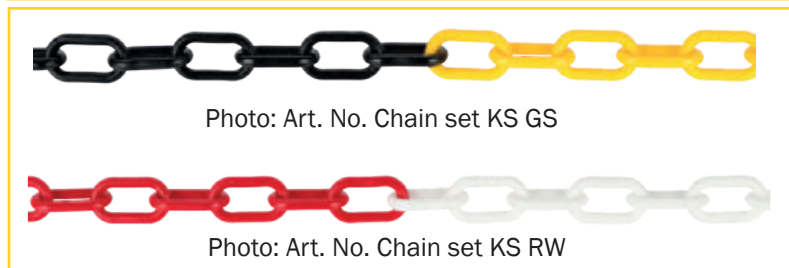
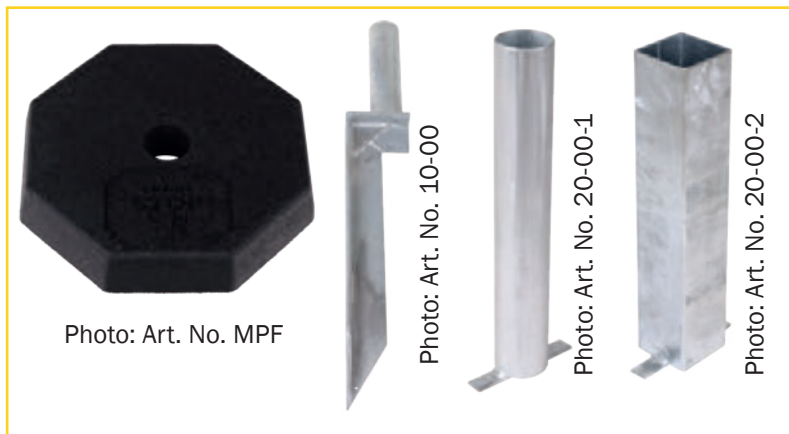

Barrier post with eyelets, height 1.000 mm, Ø 60 mm, steel, galvanized and powder coated, white post with red reflecting foil, TÜV-certified

Art. No.	Color	Weight
10-10-1	yellow-black	3,5 kg
10-20-1	red-white with red reflective tape	3,5 kg
Accessories		
MPF	Octagonal base plate, for Ø 60 mm posts, 37 cm, recycling material	7,0 kg
10-00	Impact ground sleeve, for Ø 60 mm posts, galvanized	4,5 kg
20-00-1	Ground sleeve, for Ø 60 mm posts, galvanized	2,7 kg
20-00-2	Ground sleeve, for 74 x 74 mm posts, galvanized	3,0 kg
Kettenset KS GS	Chain set, yellow-black, 6 mm, 25 m	1,5 kg
Kettenset KS RW	Chain set, red-white, 6 mm, 25 m	1,5 kg
30-00	Slider plate for posts with a 120 x 195 mm base plate	2,1 kg



aus Stahl

# SINGLE BARRIER POSTS FOR CONCRETE SETTING



other RAL colors available



Customized versions possible!



**TÜV-certified for you!**



Photo: Delivery incl. mounting iron



Photo: Art. No. 20-10+Oesen

Photo: Art. No. 20-20+Oesen

Photo: Art. No. 20-30+Oesen

Photo: Art. No. 20-40+Oesen

Photo: Art. No. 20-10

Photo: Art. No. 20-20

Photo: Art. No. 20-30

Photo: Art. No. 20-40

Art. No.	Description	Weight
<b>Barrier post to set in concrete with eyelets, steel, galvanized and powder coated, height 1.400 mm, red-white post with red reflecting foil, mounting rod included, TÜV-certified</b>		
20-10+Oesen	Barrier post red-white roand, Ø 60 mm, with eyelets	5,7 kg
20-20+Oesen	Barrier post yellow-black roand, Ø 60 mm, with eyelets	5,7 kg
20-30+Oesen	Barrier post red-white square, 70 x 70 mm, with eyelets	6,2 kg
20-40+Oesen	Barrier post yellow-black square, 70 x 70 mm, with eyelets	6,2 kg
<b>Barrier post to set in concrete, steel, galvanized and powder coated, height 1.400 mm, red-white post with red reflecting foil, mounting rod included, TÜV-certified</b>		
20-10	Barrier post red-white roand, Ø 60 mm	5,5 kg
20-20	Barrier post yellow-black roand, Ø 60 mm	5,5 kg
20-30	Barrier post red-white square, 70 x 70 mm	6,1 kg
20-40	Barrier post yellow-black square, 70 x 70 mm	6,1 kg



other RAL  
colors  
available



Steel

## CHAIN POST SET

The chain post set consists of six posts, mobile base plates (7 kg) and a polyethylene chain with a total length of 25 m. The chain post set is available in red-white with red reflecting foil and in yellow-black.



Art. No.	Description	Weight
KPS-GS	Chain post set yellow-black	72,5 kg
KPS-RW	Chain post set red-white with red reflecting foil	72,5 kg

Use outdoors and indoors



**Steel posts: TÜV-certified for you!**







other RAL  
colors  
available



Steel

## TRANSPORT RACK WITH CHAIN POST SET

The transport rack for the chain post set is the best solution to move and store the individual components. Easy handling and transport of the items are granted by casters.

Art. No.	Description	Weight
KPS-TG-GS	Transport rack and chain post set yellow-black: transport rack, 6 galvanized and powder coated posts with eyelets (Ø 60 mm, height 1.000mm), 6 octagonal base plates à 7 kg, 25 m polyethylene chain	92,0 kg
KPS-TG-RW	Transport rack and chain post set red-white: transport rack, 6 galvanized and powder coated posts with eyelets (Ø 60 mm, height 1.000mm), 6 octagonal base plates à 7 kg, 25 m polyethylene chain	92,0 kg
KPS-BAG	Protective storage case for transport rack with chain post set, made of hard-wearing polyester fabric for in- and outdoor use, water-resistant and UV-stable, fastening cord in hemline, black	0,4 kg

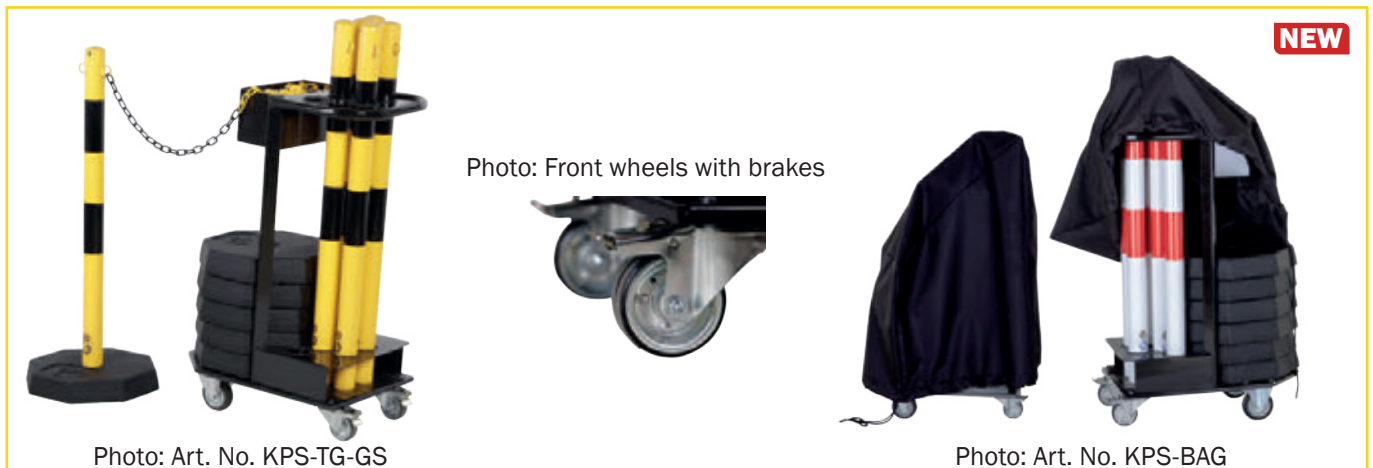

**NEW**

Photo: Front wheels with brakes

Photo: Art. No. KPS-TG-GS

Photo: Art. No. KPS-BAG



**Steel posts: TÜV-certified for you!**



Photo: Art. No. KPS-TG-RW



Polyethylene

## LIGHT CHAIN POST SET

The light chain post set consists of 6 posts (Ø 40 mm) with eyelets, 6 mobile base plates and a polyethylene chain with a total length of 10 m. Suitable for indoor use. The set of chain posts is available in yellow-black and red-white.

For indoor use.

**Chain post set, polyethylene, 6 posts, height 860 mm, Ø 40 mm, 6 black base plates, 10 m chain, including connectors**

Art. No.	Description	Weight
SET-LKP-GS	Chain post set yellow-black	11,4 kg
SET-LKP-RW	Chain post set red-white	11,4 kg



Polyethylene

## FLEXIBLE POSTS

The flexible posts are used for traffic separation and routing and for highlighting dangerous areas. Due to the fully reflective foil, the barrier post is highly perceptible and can easily be run over in an emergency without taking any damage. Afterwards, it rises on its own. Due to the bayonet lock, the product can be removed quickly.

**Flexible post, polyethylene, Ø 100 mm, tilting mechanism 360°, auto-erecting, red-white reflecting RA 2 foil, rubber foot Ø 275 x 70 mm, floor mounting via 4 drill holes à Ø 10 mm**

Art. No.	Height	Rubber foot	Weight
SB750	750 mm	Ø 275 x 70 mm	2,0 kg
SB1000	1000 mm	Ø 275 x 70 mm	2,5 kg
SB-FIX	Fixing material		

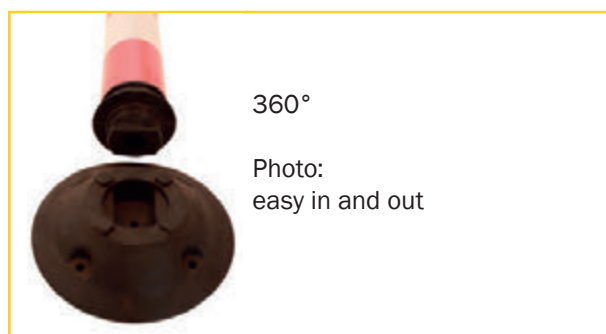



other RAL  
colors  
available

Steel

## FOLDABLE PARKING POSTS

The foldable parking barriers and locking posts represent a fast and uncomplicated option for securing parking and passage areas against unauthorized use.

Depending on the type the versions can be bolted to the floor or put in concrete; they can either be locked with a padlock or with an integral lock.

The conspicuous red-white coloring with red reflecting foil allows fast detection to prevent damages. When folded, the parking barriers and locking posts can be passed without any problems. The fixing material is not included in the delivery.

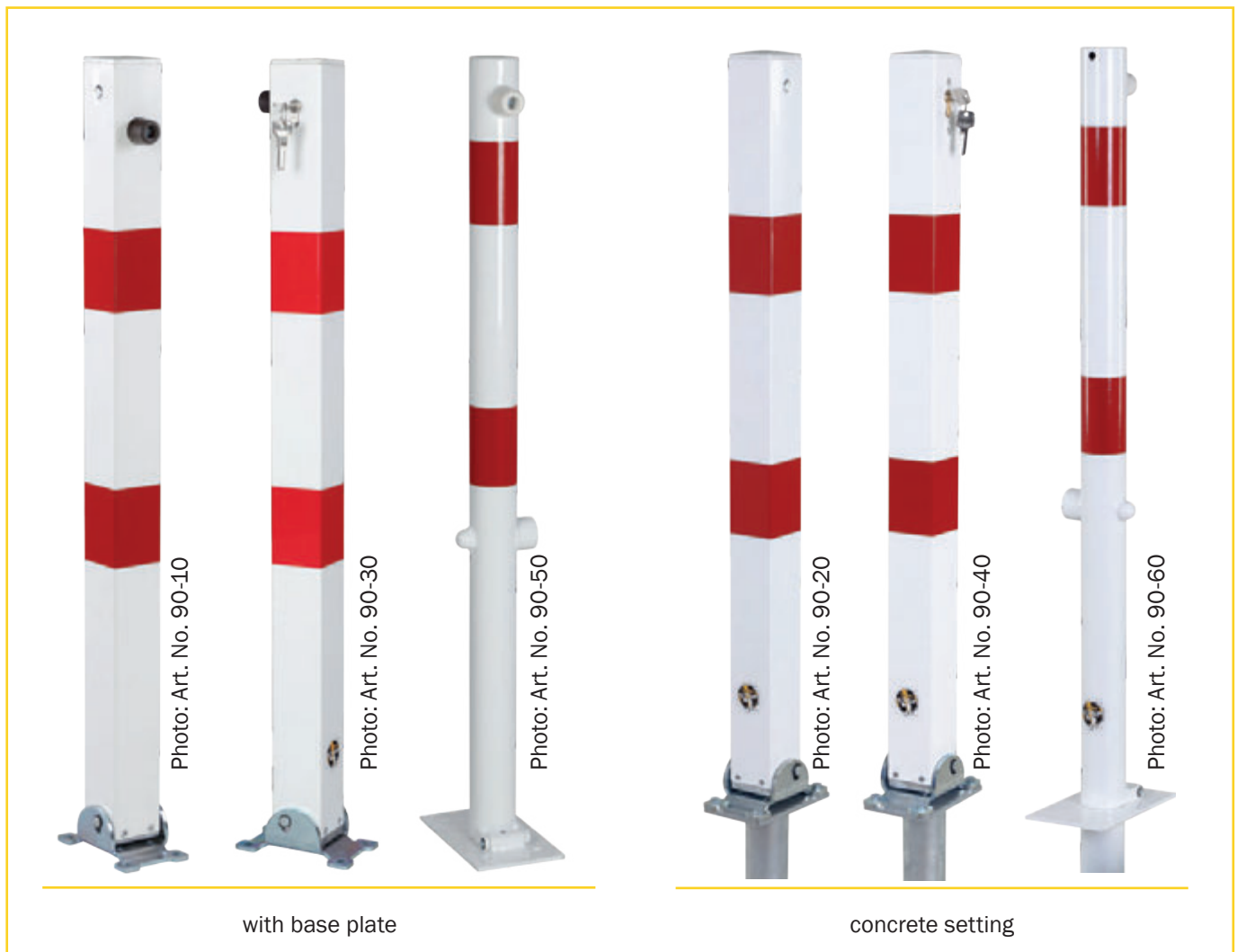

Art. No.	Description	Weight
<b>Folding parking post, white with red reflective foil, galvanized, height 1000 mm</b>		
90-10	With base plate, square 70 x 70 mm, with triangular lock, 4 drill holes Ø 12,5 mm	7,7 kg
90-30	With base plate, square 70 x 70 mm, key operated and three keys, 4 drill holes Ø 12,5 mm	7,7 kg
90-50	With base plate, roand Ø 60 mm, with triangular lock, 4 drill holes Ø 11 mm	7,7 kg
90-20	Concrete setting, square 70 x 70 mm, with triangular lock, total height 1400 mm	12,0 kg
90-40	Concrete setting, square 70 x 70 mm, key operated and three keys, total height 1400 mm	12,0 kg
90-60	Concrete setting, roand Ø 60 mm, with triangular lock, total height 1400 mm	12,0 kg





other RAL  
colors  
available



Steel  
**TILTABLE PARKING POST TYPE BUTTERFLY**

Tiltable parking post type butterfly, red-white, with red reflecting foil, galvanized, height 500 mm, width 600 mm, for floor mounting



Photo: Art. No. 90-90 with triangular lock



Photo: Art. No. 90-100 with locking pin

Art. No.	Description	Weight
90-90	with triangular lock, 4 drill holes à Ø 12,5 mm	7,6 kg
90-100	with locking pin and padlock (not included in the delivery), 4 drill holes à Ø 13,0 mm	7,6 kg



Polyurethane

## FLEXIBLE POSTS

The flexible posts made of polyurethane are an inexpensive entry-level version for the delimitation and marking of areas. The properties of the product make so that during a collision it deforms and then returns into its original shape. The tilting effect is possible at a 360° radius. The different versions in coloring and height allow for a wide scope of application. The reflecting stripes increase safety. The posts are produced in one piece and can be bolted to the floor via 3 drill holes. Caps for a chain set are available separately.

### Flexible post, tiltable at 360°, Ø 80 mm, auto-erecting, posts with reflective warning stripes

Height	Color Orange Art. No.	Color Black Art. No.	Weight
450 mm	FP450	-	0,9 kg
750 mm	FP750	FP750 S	1,3 kg
1000 mm	FP1000	FP1000 S	1,6 kg
Fixing material 3 pieces/set			



## FLEXIBLE POST SET WITH CHAIN

6 flexible posts, tiltable at 360°, Ø 80 mm, auto-erecting, black with reflective warning stripes, 10 m chain set yellow-black, 6 caps

Art. No.	Height	Diameter	Weight
SET-FP-GS-750	750 mm	80 mm	8,0 kg
SET-FP-GS-1000	1000 mm	80 mm	10,0 kg





Rubber

## PARK STOP

The park stop is a fast and uncomplicated way to organize parking spaces and to allow a gentle stopping of vehicles. Whether parking lot or underground parking, the park stop can be used both in- and outdoors. The high-quality material is UV-stable and not affected by weather conditions. Fixed on walls the park stop can also be used as impact protection.

The product is bolted through reinforced holes.



Art. No.	Description	Length	Width	Height	Weight
PS 90	Park stop 90 cm	870 mm	152 mm	102 mm	8,0 kg
PS 180	Park stop 180 cm	1820 mm	152 mm	102 mm	17,0 kg
PS90FIX	Fixing material for Art. No. PS90				
PS180FIX	Fixing material for Art. No. PS180				

Rubber

## HEAVY-DUTY WHEEL STOP NEW

The heavy-duty version of the park stop is a massive parking space restriction and maneuvering aid for large vehicles. The wheel stop prevents damage to vehicles, buildings, and machinery alike.

Manufactured from reinforced rubber and is covered with yellow reflective foil for clear visibility. If necessary, a cable (up to Ø 20mm) can be lead underneath the wheel stop, additional recesses allow for smooth drainage. Fixation is

This heavy-duty wheel stop is manufactured from reinforced rubber. Fixing material is available separately.



Art. No.	Description	Length	Width	Height	Weight
HDWS 100	Heavy-duty wheel stop	1000 mm	300 mm	150 mm	25 kg
FS-FIX	Fixing material				



Rubber

## CURB RAMP

The curb ramps allow for barrier-free access to sidewalks. Whether garage entrances or industrial areas - motor vehicles, bicycles, wheelchairs, or forklifts find solid grip on its profiled surface. The curb ramp can also be bolted to the ground for permanent use by 3 boreholes. The channels at the bottom of the ramp can serve as water drainage or cable tunnels. The material is resistant to environmental influences and allow for long-term use.

Art. No.	Description	Width	Height	Weight
BSR100	Ramp	300 mm	100 mm	11,0 kg
BSR150	Ramp	360 mm	150 mm	20,0 kg







PVC / Rubber mix

## HOSE AND CABLE PROTECTOR

The hose and cable bridges are a quick-to-use protection for hoses and cables in traffic areas. The 3 inlets on the bottom allow the insertion of cables and hoses of up to  $\varnothing$  40 mm. The grooved bottom side prevents shifting to enable fast crossing. The hose and cable bridges are completely imbued to ensure long-term use. The variants are available in different lengths to serve all areas.



**For hoses and cables, with 3 inlets: 2 x  $\varnothing$  20 mm and 1 x  $\varnothing$  40 mm. Weight capacity: 40 t. Easily installed by one person.**

Art. No.	Description	Material	Length	Width	Height	Weight
20012	Cable bridge yellow	PVC / rubber mix	1200 mm	210 mm	65 mm	12,5 kg
20014	Cable bridge black	PVC / rubber mix	1200 mm	210 mm	65 mm	12,5 kg
20010	Cable bridge yellow	PVC / rubber mix	1500 mm	210 mm	65 mm	13,2 kg

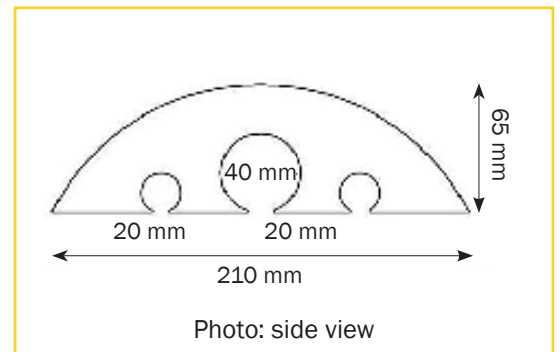

Photo: Art. No. 20010 or 20012



Rubber

## HOSE AND CABLE PROTECTORS

These hose and cable bridges are the best possible protection for hoses and cables for both in- and outdoors. They are colored all the way through. If necessary, the individual parts can be connected. The resilience allows the passage of trucks of up to 40 t and ensures functionality even in bad weather conditions. Depending on the requirements posed by the crossing vehicles, wide or narrow versions can be offered. When combined, the yellow and black protectors give the impression of a speed ramp and further increase safety.



**Trouble-free passing  
for trucks with a total  
weight of 40t**



For hoses and cables with 2 inlets à Ø 75mm, height 90 mm, with reflective foil, arbitrarily expandable. Weight capacity: 40 t. Easily installed by one person.

Art. Nro	Width	Length	Color	Weight
20020	300 mm	830 mm	black	14,6 kg
20070	680 mm	830 mm	black	29,0 kg
20025	300 mm	830 mm	yellow	14,6 kg
20075	680 mm	830 mm	yellow	29,0 kg

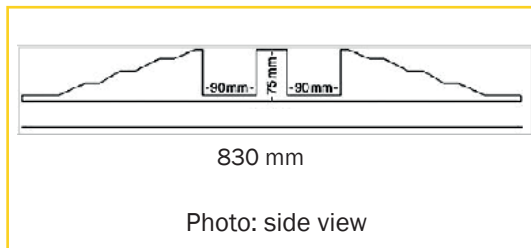

**Solid Color quality**

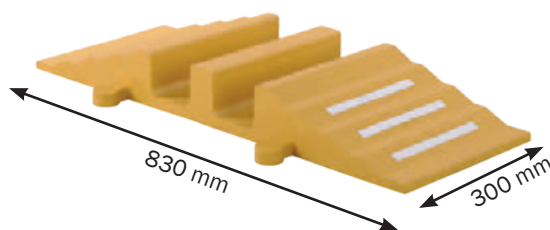
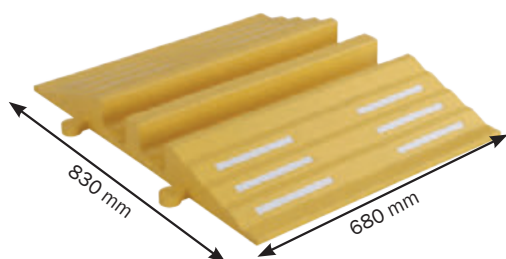
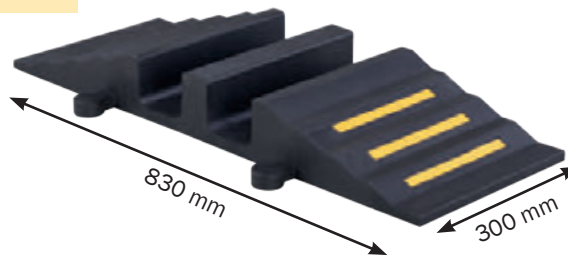
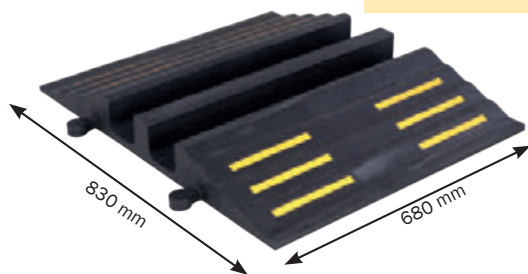



Rubber with PE-lid

## CABLE BRIDGE WITH LID

The modular cable bridges with lid are a reliable protection in streets or pathways. The yellow-black coloring allows fast recognition. The individual elements can be connected via connectors on either side. Cables are easily inserted from above. The lid is made of a highly resistant plastic. The chamfered sides allow for a smooth passage and trouble-free traffic flow. The axle load for the article 200D2K is 5t, for articles 200D3K and 200D5K it is 9t, to be passed at walking pace. The recommended crossing speed is 5-10kmh.



**Cable bridge with yellow, heavy duty lid made of PE, with handle, arbitrarily expandable via connectors, body made of black recycling rubber, with 4 drill holes, heavy load traffic possible.**

Art. No.	Number of tunnels	Length	Width	Height	Weight
200D2K	2 tunnels each 32 x 30 mm	980 mm	240 mm	45 mm	6,5 kg
200D3K	3 tunnels 50 mm x 68 / 57 / 65 mm	900 mm	500 mm	70 mm	16,5 kg
200D5K	5 tunnels each 35,3 x 38 mm	900 mm	500 mm	50 mm	17,0 kg
200D3K45R	3 tunnels 45° angle right		500 mm	70 mm	7,5 kg
200D3K45L	3 tunnels 45° angle left		500 mm	70 mm	7,5 kg
200D5K45R	5 tunnels 45° angle right		500 mm	50 mm	6,0 kg
200D5K45L	5 tunnels 45° angle left		500 mm	50 mm	6,0 kg



Photo: Art. No. 200D2K

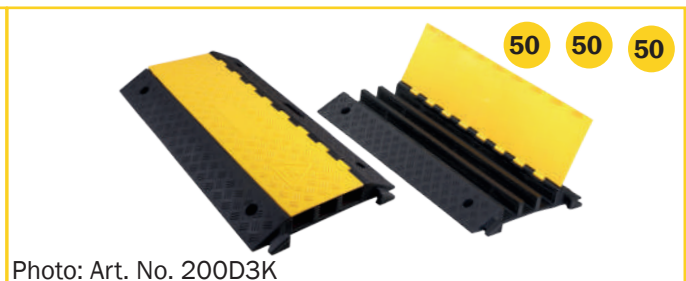

Photo: Art. No. 200D3K

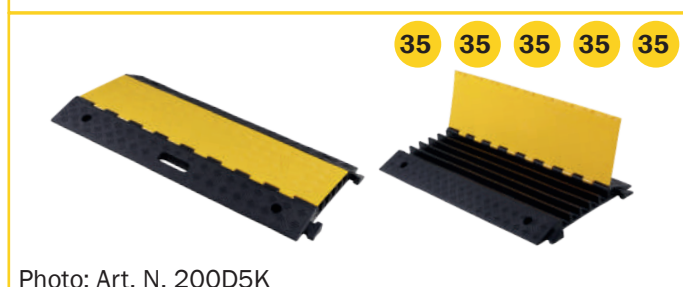

Photo: Art. N. 200D5K

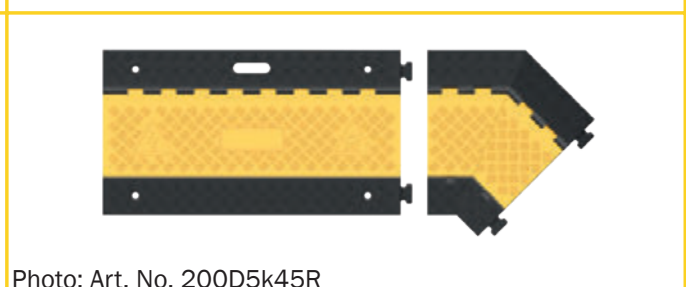

Photo: Art. No. 200D5k45R





New rubber

## SPEED RAMPS

Made of new heavy-duty rubber, self-connecting in yellow-black. Centre piece with one reflector per side.

Height: 50 mm or 75 mm.

Recommended max. speed:

Height 50 mm: max. 20 km/h

Height 75 mm: max. 10 km/h

Fixing material separately available.



**Trouble-free passing  
for trucks with a total  
weight of 40t**

Description	Height 50 mm Art. No.	Weight	Height 75 mm Art. No.	Weight
Middlepiece yellow, 500 x 400 mm	45010	9,4 kg	47510	13,4 kg
Middlepiece black 500 x 400 mm	45011	9,4 kg	47511	13,4 kg
Start piece (male), yellow, 200 x 400 mm	45020	2,7 kg	47520	3,6 kg
Start piece (male), black, 200 x 400 mm	45021	2,7 kg	47521	3,6 kg
End piece (female), yellow, 200 x 400 mm	45030	2,6 kg	47530	3,6 kg
End piece (female), black, 200 x 400 mm	45031	2,6 kg	47531	3,6 kg
Fixing material for start and end piece Art. No. FS-FIX3				
Fixing material for middle piece Art. No. FS-FIX4				



Photo: Art. No. 47521 and 47531



Photo: Art. No. 45020 and 45030

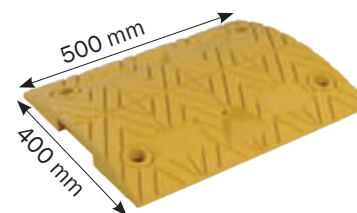

Photo: Art. No. 45010

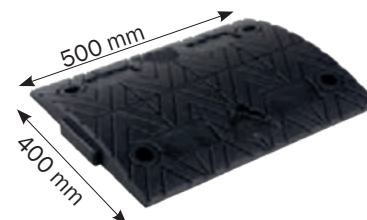

Photo: Art. No. 47511

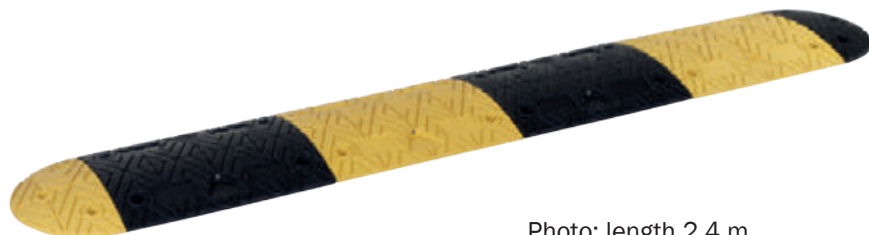

Photo: length 2,4 m



Polyethylene

## BARRIER FENCE

The barrier fences are the perfect solution for blocking off and marking obstacles. The big and solid feet in combination with the hook-and-eye element ensure high stability.

For storage and transportation, the feet can be rotated.

White and yellow type: with red-white reflective foil RA 1

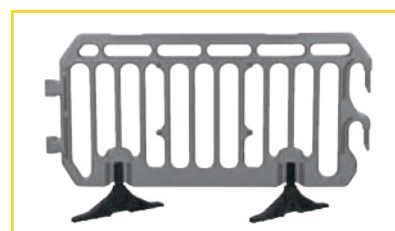
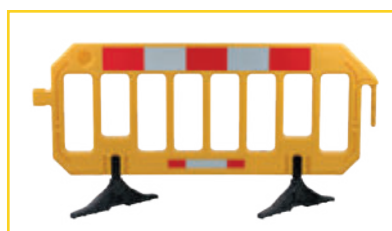
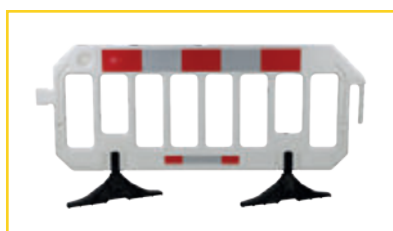

Art. No.	Description	Size	Weight
20001	Barrier fence white, foil RA1	2000 x 1000 x 50 mm	15,2 kg
20002	Barrier fence yellow, foil RA1	2000 x 1000 x 50 mm	15,2 kg
20007	Barrier fence, grey	2000 x 1000 x 50 mm	15,2 kg

## STORAGE AND TRANSPORT RACK

Art. No.	Description	Size	Weight
<b>Storage and transport rack, galvanized, stackable, lifting possible by forklift or crane, for use on crane, the base frame is equipped with a spring ring</b>			
LTG-AG	Storage and transport rack, galv.	1700 x 820 x 1250 mm	47,2 kg
VE-LTG-20001	Complete set: storage and transport rack incl. 15 pieces white barrier fences (art. no. 20001)	2000 x 820 x 1250 mm	275,5 kg
VE-LTG-20002	Complete set: storage and transport rack incl. 15 pieces yellow barrier fences (art. no. 20002)	2000 x 820 x 1250 mm	275,5 kg

Product video



Scan me



max. 15 barriers



Polyethylene

## QUICK BARRIER FENCE

The two-piece or three-piece barrier fence is a fast and cost-effective solution to shut off dangerous areas.

The two-piece or three-piece barrier fence is a fast and cost-effective solution to shut off dangerous areas.

**Barrier fence, polyethylene, modular units connectable via clips, space saving storage, yellow, red-white reflective foil RA 1, individual unit measurements 800 mm x 970 mm x 30 mm, total width 2.000 mm or 3.000 mm**



Photo: Art. No. 20005, 2 parts

Art. No.	Description	Width	Height	Thickness	Weight
20005	Barrier fence, 2 parts	2000 mm	800 mm	30 mm	6,0 kg
20006	Barrier fence, 3 parts	3000 mm	800 mm	30 mm	9,0 kg



Photo: Art. No. 20006, 3 parts

Steel

## HEIGHT RESTRICTOR

The height restrictor is an additional protection to secure loading ramps and hall doors. The warning stripes on the swinging pole warn about the max. passage height, thereby avoiding damages caused by too high vehicles.

**Height restrictor, length 2.400 mm, mounting bracket length 1.100 mm, adjustable height bracket 350-700 mm, steel, galvanized and powder coated for outdoor use, yellow-black, TÜV-certified**

Art. No.	Description	Weight
HBG-2400	Height restrictor length 2400 mm	21,0 kg



**TÜV-certified for you!**







Polyethylene

## PARKING DEVICE

This parking device is the perfect solution for temporary or permanent marking in parking lots. It is available in yellow, black, and grey. The red-white marking tape (available separately) ensures good visibility even in bad weather conditions.

For better stability, the parking device can be filled with sand (75 l). For optimum storage, the individual elements can be stacked.

When stacked, the parking devices can be connected via a separately available post which can be fixed in the ground via a ground nail (available separately). Alternating colors create high visibility.



Art. No.	Color	Height	Width	Weight
20080	yellow	530 mm	540 mm	6,9 kg
20085	black	530 mm	540 mm	6,9 kg
20090	grey	530 mm	540 mm	6,9 kg



Art. No.	Description	Weight
20091	Ground Nail, steel, galvanized, length 900 mm, impact length 370 mm	2,3 kg
20092	Post for 4 parking devices, Ø 48 mm, height 1.550 mm, material thickness 1,5 mm, for floor mounting	8,0 kg
20093	Post for 6 parking devices, Ø 48 mm, height 2.250 mm, material thickness 1,5 mm, for floor mounting	9,5 kg
20094	Red-white reflective foil RA1, PVC, length 1.700 mm, width 50 mm, self-adhesive	0,1 kg

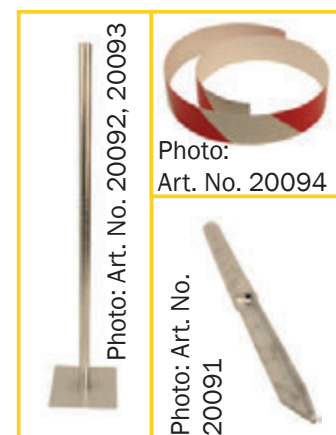



Steel

## FLOOR MARKER FOR TAPE ROLLS 50-75 MM

The floor marker helps place markings for internal pathways according to workplace regulations.

The floor marker is suitable for tape rolls of 50-75 mm and enables an easy and precise application on dry, fat- and dust-free surfaces.



**PVC or metal  
tape**



**Ground marking device and tape**

Art. No.	Description	Weight
BMG	Floor marker for tape rolls 50-75 mm	9,9 kg
<b>Ground marking tape for floor marker, PVC, 5 pieces per set, water resistant, with non-corrosive and resistant glue</b>		
SET-MB-G-50	5 rolls ground marking tape, yellow, width 50 mm, material thickness 0,16 mm, length 33 m	1,8 kg
SET-MB-G-75	5 rolls ground marking tape, yellow, width 75 mm, material thickness 0,16 mm, length 33 m	2,8 kg
SET-MB-GS-50	5 rolls ground marking tape, yellow, width 75 mm, material thickness 0,16 mm, length 33 m	2,5 kg
SET-MB-GS-75	5 rolls ground marking tape, yellow-black, width 50 mm, material thickness 0,2 mm, length 33 m	3,9 kg
<b>Ground marking tape, made of metal, can be driven over, material thickness 0,7 mm, width 100 mm</b>		
MB-ST1	100 mm x 1,5 m length, 1 piece	0,2 kg
MB-ST2	100 mm x 6,0 m length, 1 piece	1,4 kg



Photos: Art. No. BMG



**Customized versions possible!**

Steel

## RAMP GUARDRAILS

The galvanized crash stop ramp protection guard allows you to secure ramps in industrial areas where fast access is needed. The design ensures quick removal from and insertion to the mounting sleeves. The modular system can be expanded as required via start/end sleeves and middle sleeves. Meanwhile, the flat design of the mounting sleeves ensures problem-free handling of pallets and goods.



**Ramp guardrail, galvanized, Ø 60 mm, mounting sleeves with drill holes à Ø 12,5 mm**

Art. No.	Description	Height	Width	Length	Weight
RSG-1000	Ramp guardrail with cross bar, galvanized	1300 mm	1000 mm		14,6 kg
RSG-MH	Mounting sleeve with two receptacles, galvanized	200 mm	125 mm	200 mm	7,5 kg
RSG-AEH	Mounting sleeve start/end piece, galvanized	200 mm	125 mm	130 mm	3,1 kg

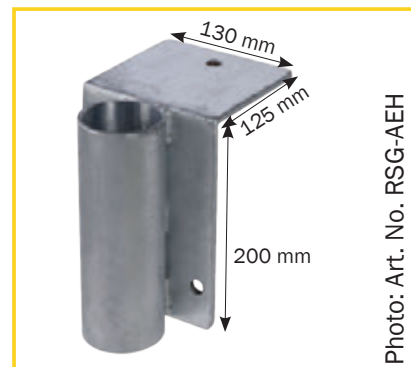



**5 Customized versions possible!**



**TÜV-certified for you!**

## Steel MODULAR TRUCK POSITIONING AID

The 3.000 mm long truck positioning aids, optimally designed for transport and mounting, are the perfect addition for loading ramps.

The modular truck positioning aid in yellow-black or red-white enables a safe and easy docking process and further protects buildings and dock shelters.

The floor anchors for the massive construction with a Ø 159 mm are available separately (Art.-nr. LKW-EFH-FIX).

To facilitate the docking process, the truck positioning aid is opened at a 15° angle in the front section.

**Modular truck positioning aid, set of 2 units right and left, steel, galvanized and powder coated for outdoor use, Ø 159 mm, length 3.000 mm, 15° angle, delivery in two pieces.**



Photo: Art. No. LKW-EFH-A GS

*Upon request, the modular truck drive-in aid can also be manufactured for setting in concrete.*

Art. No.	Description	Weight
<b>Floor mounting, with 3 base plates 300 mm x 300 mm à 6 drill holes Ø 18 mm, 15° angle, height 315 mm</b>		
LKW-EFH-A GS	yellow-black	150,0 kg
LKW-EFH-A RW	red-white	150,0 kg



Photo: Art. No. LKW-EFH-A RW  
2 pieces per side

## Polyethylene WALL AND CORNER PROTECTION

This series serves the protection of inventory and buildings. The impact energy is absorbed by aerial chambers. Our wall and corner protection is easily installed, highly resistant and equipped with reflective warning marks for better visibility. Mounting material is not included in the delivery.

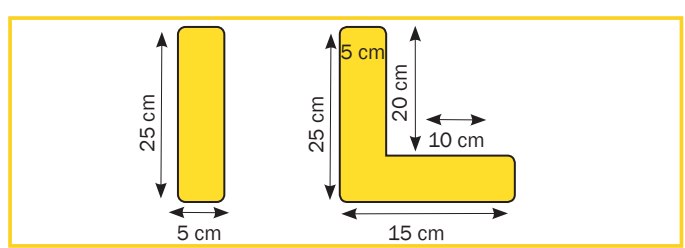

Art. No.	Description	Length	Height	Weight
30410	Wall protection	250 mm	600 mm	1,1 kg
WFIX	Fixing material for wall protection Nr. 30410			0,02 kg
30420	Corner protection	250 mm	600 mm	1,0 kg
EFIX	Fixing material for corner protection Nr. 30420			0,04 kg



TÜV-certified for you!

Steel

## TRAILER STAND

Our TÜV-certified trailer stand helps increase safety during loading and unloading of trailers up to 40 tons.

Tipping of semi-trailers is effectively avoided by using our trailer-stand.

According to BGI 582 and BGI 603, professional associations strongly recommend the use of additional protection during loading processes.



- Extra large trailer contact pad 760 x 120 mm
- Solid tires
- Easy handling
- Large base plate 470 x 425 mm

Art. No.	Description	Farbe	Height	Weight
DSV1	Trailer stand	yellow	1025 - 1344 mm	86,0 kg



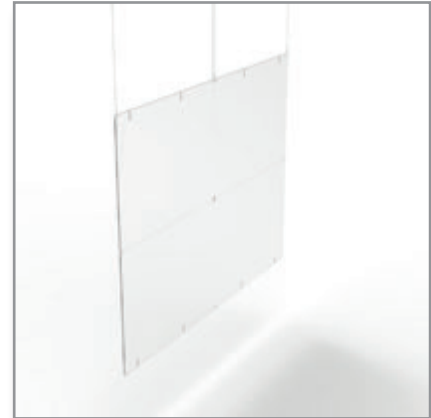

The cough screen, also going by the name corona-shield, provides the optimum protection for employees that are in direct contact with the customer. It is available in different versions and can be installed without drilling for a quick and flexible use. This mobile hygiene barrier reduces the risk of a droplet transmission (e.g. corona virus) acting as a sneeze guard.

Mounting happens within seconds by simply putting together plate and feet. The material acrylic, also called Plexiglass, renders the item light weighted and shatterproof. The flat versions have drill holes in all four corners which facilitates hanging the screens from the ceiling or connecting several ones.

Our cough monitor is easily cleaned by means of a wet cloth. Please avoid using abrasive and corrosive detergents, since they can scratch the surface.

Take responsibility and protect your employees and students from infection with this cough screen.



clear PMMA

## COUGH PROOF PROTECTION SCREEN, FLAT NEW

The flat type of the cough proof protection screen serves as a shield between employees or groups, who cannot sit, stand, or work in appropriate distance due to local circumstances, e.g. in schools or other educational institutions. Please note here the unilaterally longer side, which separates the space between neighbors even beyond the edge of the table.

The flat cough protection is available in two sizes and can be used everywhere without additional assembly. This protective barrier reduces the risk of infection (e.g. corona) by functioning as a cough and sneeze guard.

Art. No.	Description	Height	Length	Width	Thickness	Weight
CS-40X60-DV	Protective screen, flat, for standing or hanging	418 mm	600 mm	200 mm	3 mm	1,8 kg
CS-60X80-DV	Protective screen, flat, for standing or hanging	600 mm	800 mm	200 mm	3 mm	2,1 kg



Art. No. CS-40X60-DV

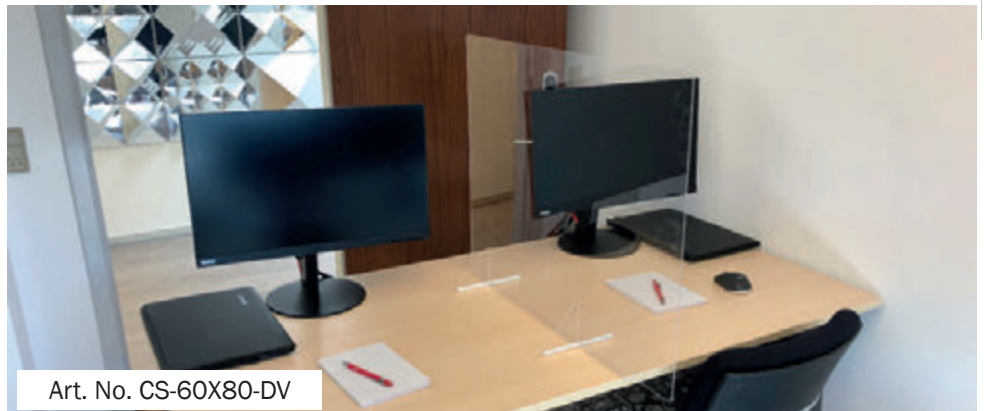

Art. No. CS-60X80-DV

clear PMMA

## COUGH PROOF PROTECTION SCREEN, CONVEX WITH SERVICE HATCH NEW

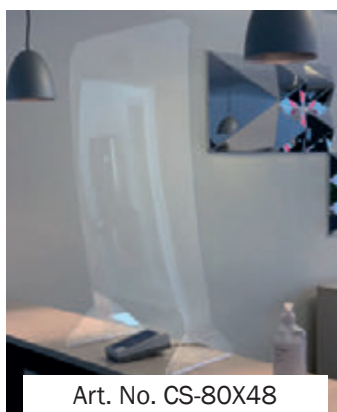

Art. No. CS-80X48

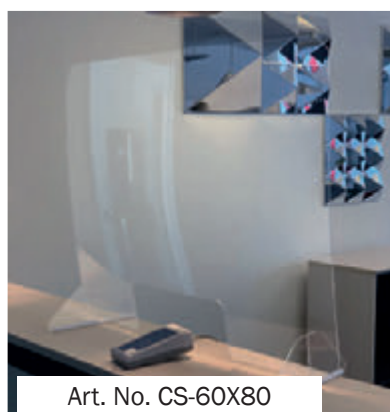

Art. No. CS-60X80



Art. No. CS-80X100

Art. No.	Description	Height	Length	Width	Thickness	Height Thrust	Length Thrust	Weight
CS-80X48	Protective screen	805 mm	475 mm	275 mm	3 mm	120 mm	300 mm	1,5 kg
CS-60X80	Protective screen	605 mm	805 mm	275 mm	3 mm	120 mm	300 mm	2,1 kg
CS-80X100	Protective screen	805 mm	1005 mm	275 mm	3 mm	120 mm	300 mm	3,3 kg

# TRAFFIC MIRRORS



TM traffic mirrors



Ice-free traffic mirrors



TM traffic mirrors



TM-I traffic mirrors



4-point ball-joint mounting bracket



TM-I traffic mirrors



Multi-use mirrors



2-point universal bracket



Mirror Explorer 180°



Mirror Subway



Mirror Panorama 180°



Mirror Trixi

Traffic Mirrors  
**FIXINGS**



4-point ball-joint mounting bracket for posts 50-85 mm

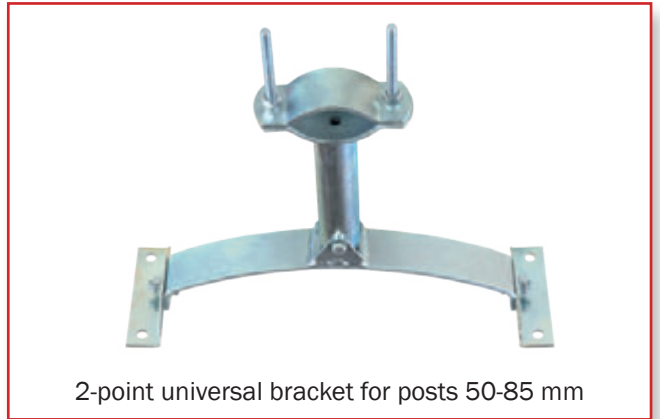

2-point universal bracket for posts 50-85 mm



Steel ring for wall fixing, Subway-mirror



Adapter for fixing on road posts

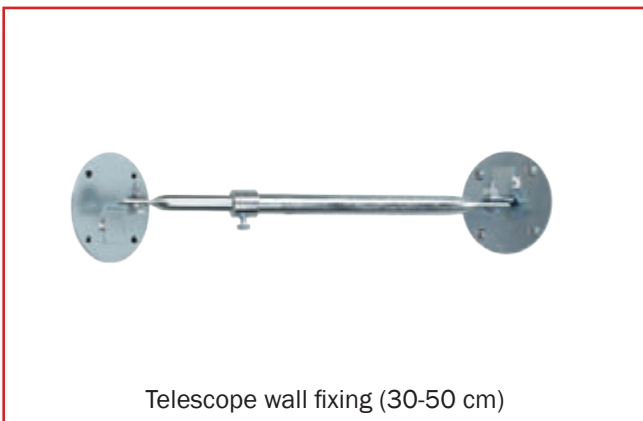

Telescope wall fixing (30-50 cm)



Telescope wall fixing (30-50 cm)

## MATERIAL OVERVIEW

	Acrylic	Polycarbonate	Inox
Material	70 % more impact resistant than glass	Nearly indestructible	Nearly indestructible
	UV-stable	UV-stable	UV-stable
	Low weight	Low weight	High temperature resistance
	Impact resistant according to DIN EN ISO 179-1	Low flammability	Chemical resistance



# TRAFFIC MIRRORS



The TÜV-certified DANCOP mirrors are characterized by very solid and durable construction. All DANCOP mirrors have a metallized backside, which enables a very clear and brilliant image and a high resistance against environmental influences.

All DANCOP mirrors are UV-stable and equipped with robust fixing brackets that are always included in the delivery. Our standard-material acrylic is 70 % more shock-resistant than glass.

### The advantages of DANCOP-mirrors:

- UV-stable
- Brilliant mirror image without distortion
- Easy installation

Finding the correct mirror	
1. Application	Indoor use Outdoor use
2. Material	Acrylic: 70 % more shock-resistant than glass Polycarbonate: nearly indestructible INOX: temperature resistance and chemical resistance
3. Size / fixing	The bigger the mirror, the better the visibility and representation

### For items as per description:

- Most massive fixing on the market: 4-point ball joint mounting bracket
- Fixing for round or rectangle post or wall fixing included
- Wind load-tested until wind force 12 (hurricane > 117 km/h)

Product video



Scan me!



Our mirrors are TÜV certified



Wind load certified up to force 12

Traffic Mirrors

# TM TRAFFIC MIRROR



Video mirror mount  
4-point ball joint mount

Traffic mirror video



**Application**  
Outdoor and indoor

**Material**  
Acrylic or Polycarbonate or Inox

**Fixing**  
Post or wall

**Warranty**  
5 years

Our TM-mirror is equipped with a white frame with red reflecting RA2 foil for a better visibility on the streets.



Photo: roand design



Photo: Back side: 4-point fixing with ball joint for an optimal fixation

Art. No.	Description	Weight	Viewing distance
TM AC 60	Acrylic, roand ø 60 cm	5,2 kg	9 - 15 m
TM AC 80	Acrylic, roand ø 80 cm	7,6 kg	15 - 22 m
TM AC 40 X 60	Acrylic 40 x 60 cm	5,0 kg	9 - 15 m
TM AC 60 X 80	Acrylic 60 x 80 cm	8,8 kg	15 - 22 m
TM AC 80 X 100	Acrylic 80 x 100 cm	12,0 kg	22 - 27 m
TM AC 100 X 120	Acrylic 100 x 120 cm	15,0 kg	27 - 32 m
TM PC 60	Polycarbonate, roand ø 60 cm	5,1 kg	9 - 15 m
TM PC 80	Polycarbonate, roand ø 80 cm	7,5 kg	15 - 22 m
TM PC 40 X 60	Polycarbonate, 40 x 60 cm	5,2 kg	9 - 15 m
TM PC 60 X 80	Polycarbonate, 60 x 80 cm	6,3 kg	15 - 22 m
TM PC 80 X 100	Polycarbonate, 80 x 100 cm	12,5 kg	22 - 27 m
TM INOX 60	Inox, roand ø 60 cm	8,3 kg	9 - 15 m
TM INOX 80	Inox, roand 80 cm	10,0 kg	15 - 22 m
TM INOX 40 X 60	Inox, 40 x 60 cm	10,0 kg	9 - 15 m
TM INOX 60 X 80	Inox, 60 x 80 cm	12,1 kg	15 - 22 m

Traffic Mirrors

# TM-B INOX

## ICE-FREE TRAFFIC MIRROR



Video of the fixing of the mirror 4-point fixing

Traffic mirror video

**Application**  
Outdoor and indoor

**Material**  
Inox

**Fixing**  
Post or wall

**Warranty**  
5 years

The combination of the INOX mirror surface and the built-in special cushions in the back prevent ice formation on the mirror surface.

Please be aware that our ice-free mirror can fog-up in cases of fast arising and freezing fog, or in exceptionally cold periods without temperature fluctuations.



Photo: roand type



Photo: Back side: 4-point fixing with ball joint for an optimal fixation



**Do you have any questions? Please call us: +49 (0) 51 71 - 58 56 90**

Art. No.	Description	Weight	Viewing distance
TM-B INOX 60	Inox, roand ø 60 cm	12,2 kg	9 - 15 m
TM-B INOX 80	Inox, roand 80 cm	14,8 kg	15 - 22 m
TM-B INOX 40 X 60	Inox, 40 x 60 cm	10,1 kg	9 - 15 m
T-B INOX 60 X 80	Inox, 60 x 80 cm	17,3 kg	15 - 22 m



Traffic Mirrors

## TM-I TRAFFIC MIRROR

Including 4-point ball joint mounting bracket for precise installation



Video mirror mount  
4-point ball joint mount



**Application**  
Outdoor and indoor

**Material**  
Acrylic or Polycarbonate

**Fixing**  
Post or wall

**Warranty**  
5 years

Our TM-I mirror increases the safety in private and industrial areas. Parking lots, private driveways, shopping centers, and railway platforms are popular operation sites as well. The red frame further enhances the visibility.



Photo: roand design

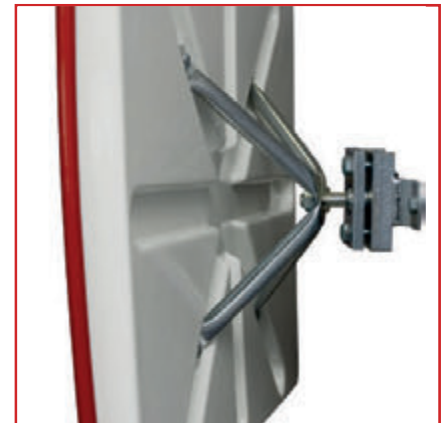

Photo: Back side: 4-point fixing with ball joint for an optimal fixation



**Request more information:**  
[info@dancop.com](mailto:info@dancop.com)

Art. No.	Description	Weight	Viewing distance
TM-I AC 50	Acrylic, roand ø 50 cm	4,2 kg	5 - 7 m
TM-I AC 60	Acrylic, roand ø 60 cm	6,0 kg	9 - 15 m
TM-I AC 80	Acrylic, roand ø 80 cm	6,4 kg	15 - 22 m
TM-I AC 40 X 60	Acrylic, 40 x 60 cm	4,4 kg	9 - 15 m
TM-I AC 60 X 80	Acrylic 60 x 80 cm	6,4 kg	15 - 22 m

Traffic Mirrors

# MULTI-USE MIRROR UNI-SIG

with or without retro-reflecting marking tape



Video mirror assembly  
Universal mirror



<b>Application</b> Outdoor and indoor	<b>Material</b> Acrylic	<b>Fixing</b> Post or wall	<b>Warranty</b> 2 years
--	----------------------------	-------------------------------	----------------------------

The UNI-SIG mirror is an economic alternative, used in areas with limited sight: in parking lots, garage exits, and shopping centers.



Photo: round version without reflecting frame



Photo: Backside with 2-point universal bracket. Horizontal or vertical use possible.

Art. No.	Description	Weight	Viewing distance
<b>With reflecting frame</b>			
US Typ1 40 X 60	Acrylic, 40 x 60 cm	4,3 kg	5 - 7 m
US Typ1 60 X 80	Acrylic, 60 x 80 cm	5,9 kg	9 - 15 m
US Typ1 80 X 100	Acrylic, 80 x 100 cm	9,0 kg	15 - 22 m
<b>Without reflecting frame</b>			
US TM-I50	Acrylic, round ø 50 cm	3,8 kg	5 - 7 m
US TM-I60	Acrylic, round ø 60 cm	4,0 kg	9 - 15 m
US TM-I 40 X 60	Acrylic, 40 x 60 cm	4,0 kg	5 - 7 m
US TM-I 60 X 80	Acrylic, 60 x 80 cm	5,6 kg	9 - 15 m
US TM-I 80 X 100	Acrylic, 80 x 100 cm	9,1 kg	15 - 22 m



Photo: Variant with reflective tape  
Art. No. US Typ1 60 X 80

Traffic Mirrors  
**EXPLORER**

180° view



Video mirror assembly  
 Universal mirror



**Application**  
 Outdoor and indoor

**Material**  
 Acrylic

**Fixing**  
 Post or wall

**Warranty**  
 2 years

The Explorer wide angle mirror with its convexity of 180° ensures an optimum field of vision. It is ideal to get an overview of production areas or traffic.



**Request more information:**  
[info@dancop.com](mailto:info@dancop.com)

Photo: Rear side 2-point universal mount. Horizontal and vertical locking possible.

Art. No.	Description	Weight	Viewing distance
EXPLORER 60	Acrylic, roand ø 60 cm	5,2 kg	9 - 15 m
EXPLORER 80	Acrylic, roand ø 80 cm	7,0 kg	15 - 20 m



Traffic Mirrors

# 180°-MIRRORS

180° view

Made of nearly indestructible polycarbonate 6 mm

## PANORAMA

## SUBWAY



**Application**  
Outdoor and indoor

**Material**  
Polycarbonate

**Fixing**  
Post or wall

**Warranty**  
5 years

Both mirrors have an especially wide angle of 180° which provides an enlarged view.

The two 180° versions vary in construction. The SUBWAY-mirror can be mounted not only on posts but directly on the wall as well, by means of the fixing ring. This way it can be seamlessly integrated in underground stations, underpasses and parking garages, making dark corners safer.

The PANORAMA-mirror additionally disposes of a white frame with green reflectors for better visibility during night-time or bad weather conditions.

Material: The nearly indestructible polycarbonate makes these the perfect mirrors for areas with much vandalism.



Photo: Optionally available: steel ring for wall fixing SUBWAY-mirror

Photo: Backside 4-point ball joint mounting bracket



Video mirror mount  
4-point ball joint mount

Art. No.	Description	Weight	Viewing distance
SUBWAY	Polycarbonate, ø 60 cm	6,0 kg	9 - 15 m
TM-PC 360 PANORAMA	Polycarbonate, ø 60 cm	9,1 kg	15 - 22 m

Traffic Mirrors

# TRIXI-MIRROR

no more blind spots



**Application**  
Outdoor and indoor

**Material**  
Acrylic

**Fixing**  
Post or wall

**Warranty**  
2 years

Our wide-angle traffic mirror Trixi helps gain view of blind spots on crossroads where cyclists and pedestrians are in danger of accidents. When turning, drivers see pedestrians or cyclists in the dangerous blind spot where otherwise they would have been overlooked.



Photo: High visibility of the cyclist in the dead angle



Photo: Backside with standard fixing (incl. adaptor)



**Against the „dead angle“**

Art. No.	Description	Weight	Viewing distance
TRIXI 35	Acrylic, roand ø 35 cm	2,0 kg	1 - 4 m
TRIXI 50	Acrylic, roand ø 50 cm	2,7 kg	5 - 7 m
TRIXI 50-H	Acrylic, roand ø 50 cm, with heating	4,2 kg	5 - 7 m



Photo: Backside with thermostat

# TRAFFIC MIRRORS



ED Traffic mirror



Multi-use mirror



The EUvex-mirrors offer a high-quality mirror image at a low entry price. Whether for traffic, industry, or trade: the EUvex safety mirrors are ideally suited to provide a better view of confusing areas. In contrast to the Dancop mirrors, the EUvex mirrors offer less selection and adjustment options and a smaller product range. The EUvex mirrors are neither TÜV-certified nor wind load certified.

### Advantages of EUvex mirrors:

- UV-stable
- Fixing bracket for road posts 50-85 mm included in the delivery
- High quality mirror image
- Easy installation

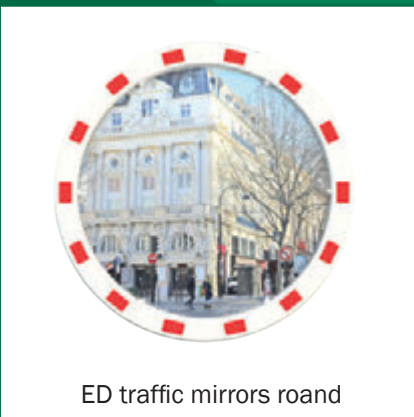

ED traffic mirrors road

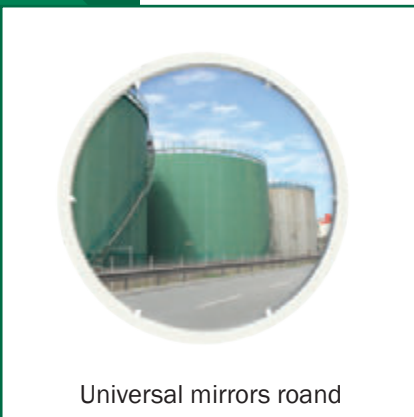

Universal mirrors road



Backside with post fixing



Traffic Mirrors

## EUvex TRAFFIC MIRRORS



**Application**  
Outdoor and indoor

**Material**  
Acrylic

**Fixing**  
Post or wall

**Warranty**  
2 years

The EUvex traffic mirror increases safety on roads and premises. Due to its robust design it is suitable for long term outdoor use. The type RA2 reflectors ensure good visibility, even in bad weather conditions.

**Material:**

The EUvex mirror surface is made of PMMA and equipped with red reflectors (Type RA2) on a white frame. It is UV-stable and weather-resistant.



Photo: roand type

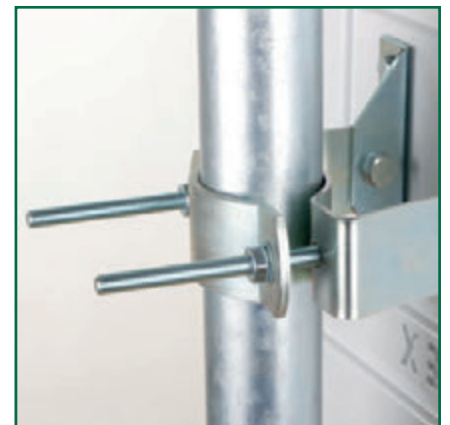

Photo: Back side with standard post fixing

Art. No.	Description	Weight	Viewing distance
ED 40 X 60	Acrylic, 40 x 60 cm	3,3 kg	9 - 15 m
ED 60 X 80	Acrylic, 60 x 80 cm	5,1 kg	15 - 22 m
ED 80 X 100	Acrylic, 80 x 100 cm	8,5 kg	22 - 27 m
ED 60	Acrylic, roand ø 60 cm	3,7 kg	9 - 15 m
ED 80	Acrylic, roand ø 80 cm	5,2 kg	15 - 22 m
ED-Wand-arm	Wall fixing, distance 20 cm	1,9 kg	



Photo: fixing for wall mounting  
Art. No. ED-Wandarm

Traffic Mirrors

# EUvex UNIVERSAL MIRRORS



**Application**  
Outdoor and indoor

**Material**  
Acrylic

**Fixing**  
Post or wall

**Warranty**  
2 years

The EUvex universal mirror is equipped with a white frame and very versatile.

**Material**

The EUvex universal mirror surface is made of PMMA, UV-stable and weather-resistant.



Photo: round version



Photo: Back with standard fixing to the post

Art. No.	Description	Weight	Viewing distance
ED-U 40 x 60	Acryl, 40 x 60 cm	1,8 kg	9 - 15 m
ED-U 60 x 80	Acryl, 60 x 80 cm	4,0 kg	15 - 22 m
ED-U 80 x 100	Acryl, 80 x 100 cm	6,6 kg	22 - 27 m
ED-U 60	Acryl, rand ø 60 cm	2,0 kg	9 - 15 m
ED-U 80	Acryl, rand ø 80 cm	4,2 kg	15 - 22 m
ED-Wandarm	Wall fixing, distance 20 cm	1,9 kg	

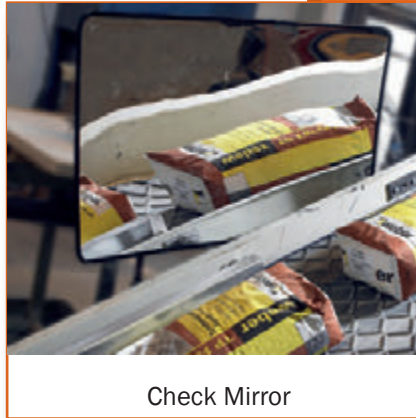

Photo: fixing for wall mounting  
Art. No. ED-Wandarm

# INDUSTRIAL MIRRORS



Check Point



Check Mirror



TM Traffic mirror



TM-I traffic mirror



Mirror multi use

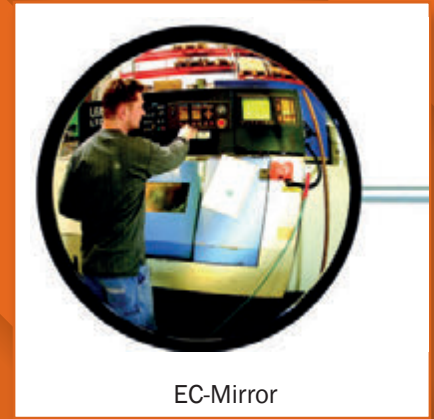

EC-Mirror



INOX HF mirror



Dome mirror 360°



Dome mirror 180°



Transpo 180° mirror

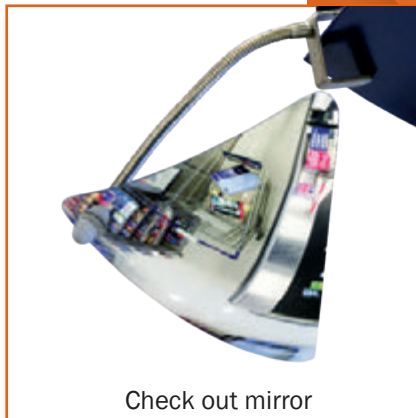

Check out mirror



Inspection mirror



Industrial mirrors  
**FIXINGS**

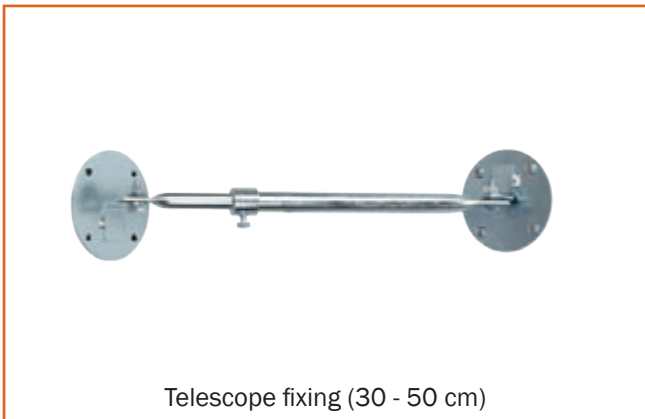
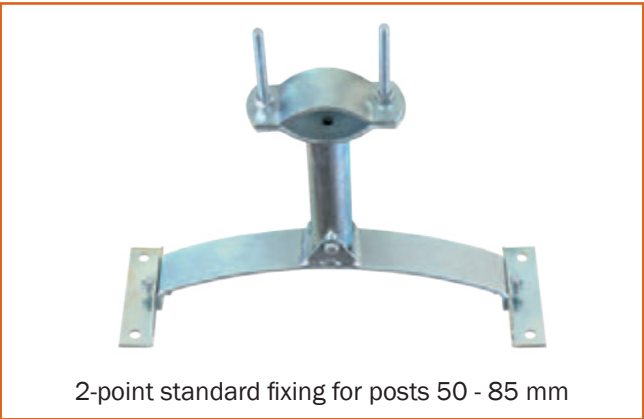

**MATERIAL OVERVIEW**

	Acrylic	Polycarbonate	Inox
<b>Material</b>	70 % more impact resistant than glass	Nearly indestructible	Nearly indestructible
	UV-resistant	UV-resistant	UV-resistant
	Light weight	Light weight	High temperature applications possible
	Impact resistant per DIN EN ISO 179-1	Low flammability	Chemical resistant

# INDUSTRIAL MIRRORS



**Do you have any questions? Please call us: +49 (0) 51 71 - 58 56 90**



The TÜV-certified DANCOP mirrors are characterized by very solid and durable construction. All DANCOP mirrors have a metallized backside, which enables a very clear and brilliant image and a high resistance against environmental influences.

All DANCOP mirrors are UV-stable and equipped with robust fixing brackets that are always included in the delivery. Our standard-material acrylic is 70 % more shock-resistant than glass.

## Advantages of DANCOP-mirrors:

- UV-stable
- Brilliant mirror image without distortion
- Easy installation

## Finding the correct mirror

1. Application	Indoor use Outdoor use
2. Material	Acrylic: 70 % more shock-resistant than glass Polycarbonate: nearly indestructible INOX: temperature resistant and chemical resistant
3. Size / fixing	The bigger the mirror, the better the visibility and representation

## For items as per description:

- Most massive fixing on the market: 4-point ball joint mounting bracket
- Fixing for round or rectangle post or wall fixing included
- Wind load-tested until wind force 12 (hurricane > 117 km/h)

Product video



Scan me!



Our mirrors are TÜV certified



Wind load certified up to force 12

Industrial Mirrors

# CHECK POINT

The yellow-black frame increases the visibility.



Video mirror mount  
Telescopic mount



**Application**  
Outdoor and indoor

**Material**  
Acrylic

**Fixing**  
Post or wall

**Warranty**  
2 years

Our check point mirror increases attention in hazardous areas of production lines. Distant workstations and blind spots are easily inspected. Workplace accidents and loss of production are effectively reduced.

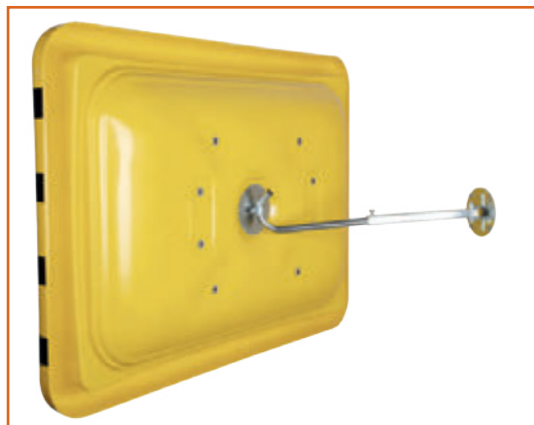

Photo: Telescopic bracket 30 - 50 cm



Photo: Upright position, horizontal-vertical position possible (bracket I or IV)

Art. No.	Description	Weight	Viewing distance
CP 30 X 50	Acrylic, 30 x 50 cm	1,8 kg	5 - 7 m
CP 40 X 60	Acrylic, 40 x 60 cm	3,0 kg	7 - 12 m
CP 60 X 90	Acrylic, 60 x 90 cm	5,8 kg	12 - 25 m
<b>Alternative brackets for mirrors in sizes 40 x 60 and 60 x 90</b>			
Bracket I	4-point ball joint bracket for wall and post mounting (ø 50 - 85 mm) 2.6 kg		
Bracket IV	Universal bracket for wall and post mounting (ø 50 - 85 mm) 2.4 kg		



Photo above: 4-point ball joint mount  
Photo below: 2-point universal mount



Industrial Mirrors

# CHECK MIRROR



**Application**  
Indoor

**Material**  
Acrylic

**Fixing**  
Wall

**Warranty**  
2 years

This check mirror has been developed specifically for supervising production lines. The concavity of the mirror enlarges the reflection and control by one person is possible. One-meter distance between product and mirror is recommended.



**Request more information:**  
[info@dancop.com](mailto:info@dancop.com)

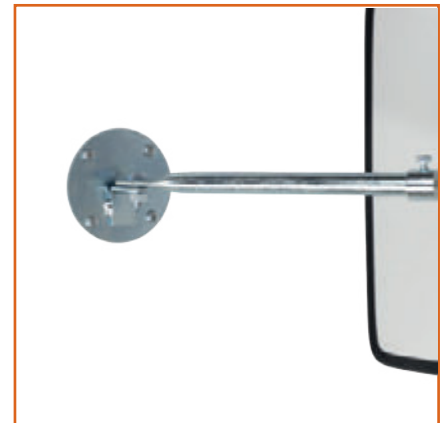

Photo: Standard bracket Telescopic wall bracket for optimal adjustment

Art. No.	Description	Weight	Viewing distance
CM 30 X 50	Acrylic, 30 x 50 cm	1,0 kg	1 m
CM 40 X 60	Acrylic, 40 x 60 cm	1,4 kg	1 m
CM 60 X 90	Acrylic, 60 X 90 cm	2,6 kg	1 m

Industrial Mirrors

# TM TRAFFIC MIRROR



Video mirror mount  
4-point ball joint mount



**Application**  
Outdoor and indoor

**Material**  
Acrylic, Polycarbonate, Inox

**Fixing**  
Post or wall

**Warranty**  
5 years

Our TM-mirror is equipped with a white frame with red reflecting RA2 foil for a better visibility on the streets.

Art. No.	Description	Weight	Viewing distance
TM AC 60	Acrylic, roand ø 60 cm	5,2 kg	9 - 15 m
TM AC 80	Acrylic, roand ø 80 cm	7,6 kg	15 - 22 m
TM AC 40 X 60	Acrylic, 40 x 60 cm	5,0 kg	9 - 15 m
TM AC 60 X 80	Acrylic, 60 x 80 cm	8,8 kg	15 - 22 m
TM AC 80 X 100	Acrylic, 80 x 100 cm	12,0 kg	22 - 27 m
TM AC 100 X 120	Acrylic, 100 x 120 cm	15,0 kg	27 - 32 m
TM PC 60	Polycarbonate, roand ø 60 cm	5,1 kg	9 - 15 m
TM PC 80	Polycarbonate, roand ø 80 cm	7,5 kg	15 - 22 m
TM PC 40 X 60	Polycarbonate, 40 x 60 cm	5,2 kg	9 - 15 m
TM PC 60 X 80	Polycarbonate, 60 x 80 cm	6,3 kg	15 - 22 m
TM PC 80 X 100	Polycarbonate, 80 x 100 cm	12,5 kg	22 - 27 m
TM INOX 60	Inox, roand ø 60 cm	8,3 kg	9 - 15 m
TM INOX 80	Inox, roand ø 80 cm	10,0 kg	15 - 22 m
TM INOX 40 X 60	Inox, 40 x 60 cm	10,0 kg	9 - 15 m
TM INOX 60 X 80	Inox, 60 x 80 cm	12,1 kg	15 - 22 m



Photo: roand design



Photo: Back 4-point ball joint mount for optimal adjustment

Industrial Mirrors

## TM-B INOX

### ICE-FREE TRAFFIC MIRROR



Video mirror mount  
4-point ball joint mount



**Application**  
Outdoor and indoor

**Material**  
Inox

**Fixing**  
Post or wall

**Warranty**  
5 years

The combination of the INOX mirror surface and the built-in special cushions in the back prevent ice formation on the mirror surface.

Please be aware that our ice-free mirror can fog-up in cases of fast arising and freezing fog, or in exceptionally cold periods without temperature fluctuations.



Photo: Road design



Photo: Back 4-point ball joint mount for optimal adjustment

Art. No.	Description	Weight	Viewing distance
TM-B INOX 60	INOX, roand ø 60 cm	12,2 kg	9 - 15 m
TM-B INOX 80	INOX, roand ø 80 cm	14,8 kg	15 - 22 m
TM-B INOX 40 X 60	Inox, 40 x 60 cm	10,1 kg	9 - 15 m
TM-B INOX 60 X 80	Inox, 60 x 80 cm	17,3 kg	15 - 22 m



Industrial Mirrors

# TM-I TRAFFIC MIRROR

Including 4-point ball joint mounting bracket for precise installation



Video mirror mount  
4-point ball joint mount



**Application**  
Outdoor and indoor

**Material**  
Acrylic

**Fixing**  
Post or wall

**Warranty**  
5 years

The TM-I industrial mirror helps secure hazardous areas. The massive construction ensures long-term use thus justifying the investment.



Photo: roand design



Photo: Back 4-point ball joint mount for optimal adjustment

Art. No.	Description	Weight	Viewing distance
TM-I AC 50	Acrylic, roand ø 50 cm	4,2 kg	5 - 7 m
TM-I AC 60	Acrylic, roand ø 60 cm	6,0 kg	9 - 15 m
TM-I AC 80	Acrylic, roand ø 80 cm	6,4 kg	15 - 22 m
TM-I AC 40 X 60	Acrylic, 40 x 60 cm	4,4 kg	9 - 15 m
TM-I AC 60 X 80	Acrylic, 60 x 80 cm	6,4 kg	15 - 22 m

Industrial Mirrors

# UNI-SIG MULTI-USE MIRROR

with or without reflecting frame



Video mirror assembly  
Universal mirror

<b>Application</b> Outdoor and indoor	<b>Material</b> Acrylic	<b>Fixing</b> Post or wall	<b>Warranty</b> 2 years
--	----------------------------	-------------------------------	----------------------------

The UNI-SIG mirror is an economic alternative, used in areas with limited sight: in parking lots, garage exits, and shopping centers.



Photo: roand design



Photo: Rear side 2-point universal mount: horizontal and vertical locking possible!

Art. No.	Description	Weight	Viewing distance
<b>with retroreflective warning tape</b>			
US Typ1 40 X 60	Acrylic, 40 x 60 cm	4,3 kg	5 - 7 m
US Typ1 60 X 80	Acrylic, 60 x 80 cm	5,6 kg	9 - 15 m
US Typ1 80 X 100	Acrylic, 80 x 100 cm	9,1 kg	15 - 22
<b>Without reflective tape</b>			
US TM-I 50	Acrylic, roand ø 50 cm	3,8 kg	5 - 7 m
US TM-I 60	Acrylic, roand ø 60 cm	4,0 kg	9 - 15 m
US TM-I 40 X 60	Acrylic, 40 x 60 cm	4,3 cm	5 - 7 m
US TM-I 60 X 80	Acrylic, 60 x 80 cm	5,6 kg	9 - 15 m
US TM-I 80 X 100	Acrylic, 80 x 100 cm	9,1 kg	15 - 22 m



Photo: Variant with reflective tape

Industrial Mirrors

# SM OBSERVATION MIRROR



**Application**  
Outdoor and indoor

**Material**  
Acrylic

**Fixing**  
Wall

**Warranty**  
2 years

The massive construction ensures long-term use both in- and outdoors. The various sizes enable a wide range of application.



Photo: roand design



Photo: View of the rear wall shell, standard mount: telescopic wall mount 30 - 50 cm

Art. No.	Description	Weight	Viewing distance
SM 35	Acrylic, roand ø 35 cm	1,2 kg	1 - 4 m
SM 50	Acrylic, roand ø 50 cm	2,0 kg	5 - 7 m
SM 60	Acrylic, roand ø 60 cm	2,8 kg	9 - 15 m
SM 80	Acrylic, roand ø 80 cm	4,5 kg	15 - 22 m
SM 40 X 60	Acrylic, 40 x 60 cm	2,6 kg	9 - 15 m
SM 60 X 80	Acrylic, 60 x 80 cm	4,4 kg	15 - 22 m



Industrial Mirrors

## EC OBSERVATION MIRROR



**Application**  
Outdoor and indoor

**Material**  
Acrylic

**Fixing**  
Wall

**Warranty**  
2 years

The most economic type of all our mirrors is especially made for warehouses and production areas. The included telescope bracket ensures perfect positioning.

Art. No.	Description	Weight	Viewing distance
<b>Indoor</b>			
EC-RS 30	Acrylic, roand ø 30 cm	0,8 kg	1 - 4 m
EC-RS 40	Acrylic, roand ø 40 cm	1,0 kg	1 - 5 m
EC-RS 50	Acrylic, roand ø 50 cm	1,2 kg	5 - 7 m
EC-RS 60	Acrylic, roand ø 60 cm	1,2 kg	9 - 15 m
EC-RS 70	Acrylic, roand ø 70 cm	1,8 kg	12 - 17 m
EC-RS 80	Acrylic, roand ø 80 cm	2,2 kg	15 - 22 m
EC-RS 40 X 60	Acrylic, 40 x 60 cm	1,4 kg	1 - 5 m
EC-RS 60 X 80	Acrylic, 60 x 80 cm	2,4 kg	9 - 15 m
<b>Outdoor and indoor</b>			
EC-US 30	Acrylic, roand ø 30 cm	1,1 kg	1 - 4 m
EC-US 40	Acrylic, roand ø 40 cm	1,4 kg	1 - 5 m
EC-US 50	Acrylic, roand ø 50 cm	2,0 kg	5 - 7 m
EC-US 60	Acrylic, roand ø 60 cm	2,6 kg	9 - 15 m
EC-US 70	Acrylic, roand ø 70 cm	3,4 kg	12 - 17 m
EC-US 80	Acrylic, roand ø 80 cm	4,2 kg	15 - 22 m



Photo: rectangular version

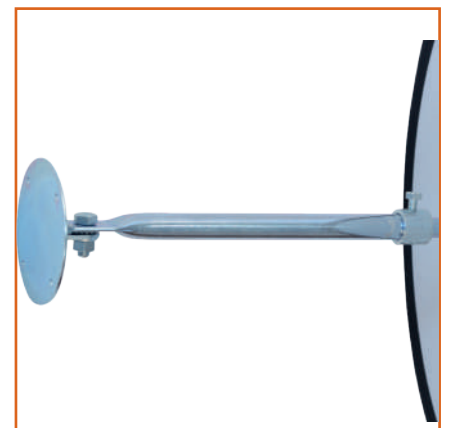
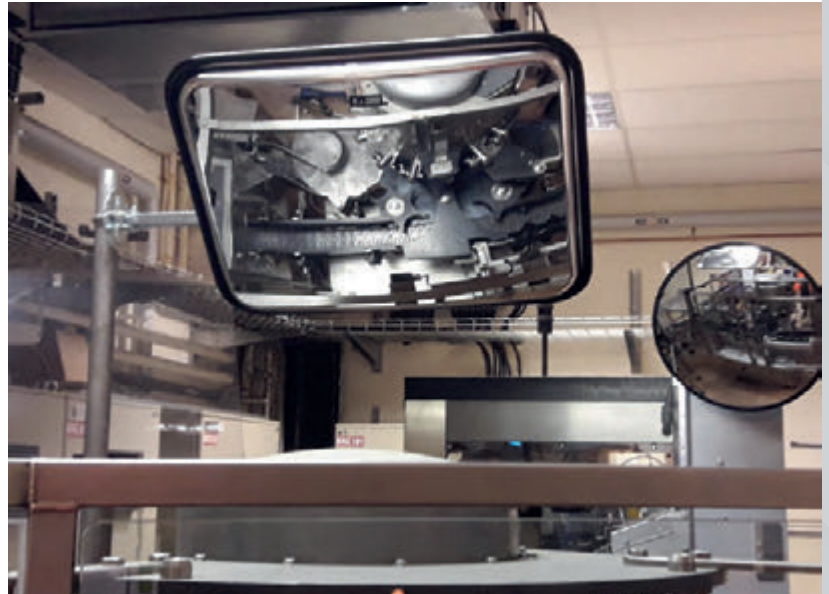

Photo: Standard bracket: Telescopic wall bracket 30 - 50 cm

Industrial Mirrors

# INOX INDUSTRIAL MIRROR

Heat resistant up to 350°C with detachable PVC frame



**Application**  
Outdoor and indoor

**Material**  
Inox

**Fixing**  
Wall

**Warranty**  
2 years

This mirror is made of non-corrosive INOX so it can be used in high temperature areas as well as in the food industry. The PVC frame can be removed after installation.



Photo: rectangular version



Photo: Standard bracket: Telescopic wall bracket 30 - 50 cm

Art. No.	Description	Weight	Viewing distance
INOX HF 45 X 60	Inox, 45 x 60 cm	3,6 kg	9 - 15 m
INOX HF 60	Inox, roand ø 60 cm	5,5 kg	9 - 15 m
INOX HF 60 X 80	Inox, 60 x 80 cm	4,7 kg	15 - 22 m
INOX HF 80	Inox, roand ø 80 cm	5,8 kg	15 - 22 m

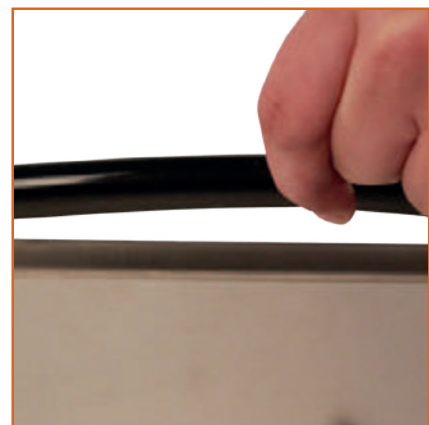

Photo: Removable PVC strand

Industrial Mirrors  
**TRANSPO 180° MIRROR**



<b>Application</b> Indoor	<b>Material</b> Acrylic	<b>Fixing</b> Wall	<b>Warranty</b> 2 years
------------------------------	----------------------------	-----------------------	----------------------------

Our mirror Transpo grants a 180° view so that wide areas can be overseen. The massive construction ensures long-term use.



Photo: Standard mount: telescopic wall mount 30 - 50 cm



**Request more information:**  
[info@dancop.com](mailto:info@dancop.com)

Art. No.	Description	Weight	Viewing distance
TRANSPO AC 45	Acrylic, 45 cm	1,4 kg	1 - 2 m
TRANSPO AC 60	Acrylic, 60 cm	1,6 kg	9 - 15 m
TRANSPO AC 80	Acrylic, 80 cm	3,4 kg	15 - 20 m



Industrial Mirrors

## MIRROR TRANSPO AC 25

For the safety of forklift-drivers.

Ideal as a rear-view mirror for forklift trucks.



**Application**  
Indoor

**Material**  
Acrylic

**Fixing**  
Screw-on

**Warranty**  
2 years

The mirror increases the safety of both forklift driver and pedestrians. The clear representation facilitates a quick grasp of the situation. Via ball joint mounting bracket, the mirror is adjustable at a 180° angle.



Photo: Application



Photo: Ball joint mount



**Do you have any questions? Please call us: +49 (0) 51 71 - 58 56 90**

Art. No.	Description	Weight	Viewing distance
TRANSPO AC 25-S	Acrylic, 25 cm	0,4 kg	1 - 2 m

Industrial Mirrors

## DOME MIRROR 360°

More safety in your logistic or sales areas



BM 360

Video Dome mirror

Industrial Mirrors

## DOME MIRROR 90° & 180°

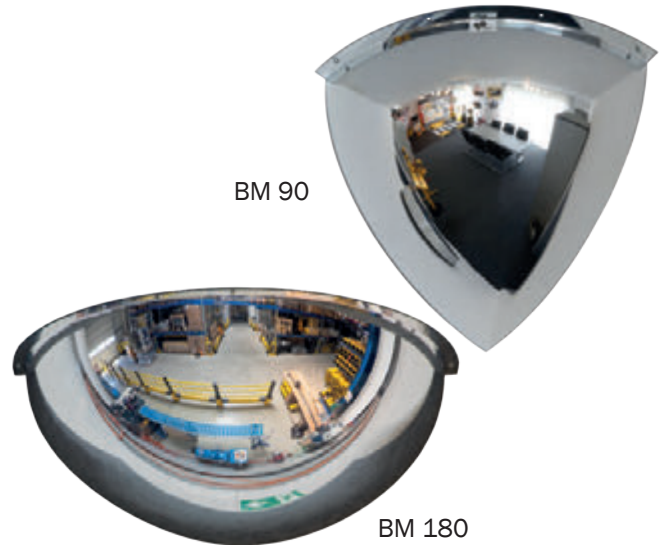

BM 90

BM 180

**Application**  
Indoor

**Material**  
Acrylic or polycarbonate

**Fixing**  
Chain / Ceiling

**Warranty**  
2 years

Due to the 360° overview, our globe mirror is recommended for surveillance in industrial areas. It helps prevent accidents at crossroads with forklift circulation. It can be hung with chains or directly screwed onto the ceiling.

Our globe mirrors 90° and 180° give a global overview at T-junctions and other hazardous areas. These mirrors make the traffic movements visible in workplaces thus reducing the risk of injuries. The mirrors are directly fixed to the wall or ceiling.

Art. No. BM 360	Description	Weight	Depth	Viewing distance
BM 60-3	Acrylic, ø 60 cm	1,1 kg	29 cm	16 - 20 m
BM 80-3	Acrylic, ø 80 cm	1,5 kg	35 cm	21 - 30 m
BM 90-3	Acrylic, ø 90 cm	2,3 kg	37 cm	30 - 40 m
BM 100-3	Acrylic, ø 100 cm	2,8 kg	38 cm	40 - 50 m
BM 125-3	Acrylic, ø 125 cm	4,2 kg	49 cm	50 - 60 m
BM PC 60	Polycarbonate, ø 60 cm	1,1 kg	29 cm	16 - 20 m
Chain				
3095	Chain for BM bis ø 100 cm	0,4 kg	Length: 4 x 1000 mm	
3097	Chain for BM 125-3	0,6 kg	Length: 4 x 2500 mm	

Art. No. BM 180	Description	Weight	Depth	Viewing distance
BM 60-2	Acrylic, 60 cm	0,5 kg	29 cm	10 - 15 m
BM 80-2	Acrylic, 80 cm	1,0 kg	35 cm	15 - 20 m
BM 100-2	Acrylic, 100 cm	1,3 kg	38 cm	25 - 30 m
BM 90				
BM 60-1	Acrylic, 60 cm	0,3 kg	29 cm	10 - 15 m
BM 80-1	Acrylic, 80 cm	0,4 kg	35 cm	15 - 20 m
BM 100-1	Acrylic, 100 cm	0,7 kg	38 cm	25 - 30 m



Photo: Chain set for ceiling mounting

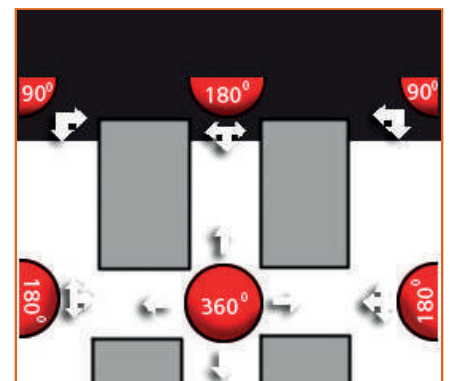

Photo: Use of the different mirror variants

Industrial Mirrors

## FLAT MIRROR MADE OF ACRYLIC



Industrial Mirrors

## CHECK OUT MIRROR



**Application**  
Indoor

**Material**  
Acrylic

**Fixing**  
Wall / Ceiling

**Warranty**  
2 years

Our multi-use flat mirror was designed for shops and commerce. The mirror is made of acrylic with an aluminum frame. It can be installed directly on the wall or hanging from the ceiling via chains (separately available).

The check out mirror was developed to effectively check "dead areas". The fixing can be adjusted as per your needs.

Art. No.	Description	Weight	Viewing distance
IP AC 30 X 40	Acrylic, 30 x 40 cm	0,7 kg	1 - 4 m
IP AC 40 X 60	Acrylic, 40 x 60 cm	1,1 kg	1 - 6 m
IP AC 60 X 80	Acrylic, 60 x 80 cm	2,1 kg	1 - 6 m
IP AC 30 X 100	Acrylic, 30 x 100 cm	1,5 kg	1 - 8 m
IP AC 50 X 100	Acrylic, 50 x 100 cm	1,5 kg	1 - 8 m
IP AC 75 X 100	Acrylic, 75 x 100 cm	3,2 kg	1 - 10 m

Art. No.	Description	Weight	Viewing distance
T 3	Acrylic, 36 x 30 x 30 cm	0,5 kg	1 - 3 m
T 5	Acrylic, 38 x 34 x 34 cm	0,6 kg	1 - 3 m



Photo: Backside flat mirror



Photo: Backside T 3



Photo: Backside T 5, 2 mounting options are included in the scope of delivery



Industrial Mirrors

## SPEXI INSPECTION MIRROR

The wheels are reinforced with polyurethane and equipped with bearings for long-term use.

Telescopic aluminum handlebar.

Extendable 40-110 cm.

\*one year warranty on the electric parts.



**Application**  
Outdoor and indoor use

**Material**  
Acrylic

**Usage**  
Airports or garage

**Warranty**  
5 years\*

Our inspection mirror allows to check even parts of vehicles and machines that are difficult to access. It's equipped with LED lighting and can be used night and day. Its low weight allows for easy handling and carrying.

Now available with matching transport case, fitting all versions for even easier handling and protection of the mirror.



Photo: in the garage



Photo: backside of the mirror  
Art. No. IS 35

Art. No.	Description	Weight
IS 20 X 40	with wheels, 20 x 40 cm	1,6 kg
IS 25	round, ø 25 cm	1,0 kg
IS 35	with wheels, round ø 35 cm	1,4 kg
IS-L 20 X 40	with wheels and light, 20 x 40 cm	1,6 kg
IS-L 25	with light, round, ø 25 cm	1,0 kg
IS-L 35	with wheels and light, round ø 35 cm	1,4 kg
IS-BAG	Protective storage and transport case for Dancop inspection mirrors	0,8 kg



Photo: Art. No. IS-BAG

# INDUSTRIAL MIRRORS



ED-I Industrial mirrors



Surveillance mirrors EF



The EUvex-mirrors offer a high-quality mirror image at a low entry price. Whether for traffic, industry, or trade: the EUvex safety mirrors are ideally suited to provide a better view of confusing areas. In contrast to the Dancop mirrors, the EUvex mirrors offer less selection and adjustment options and a smaller product range. The EUvex mirrors are neither TÜV-certified nor wind load certified.

### Advantages of EUvex mirrors:

- UV-stable
- Fixing bracket for road posts 50-85 mm included in the delivery
- High quality mirror image
- Easy installation



ED traffic mirror



Universal mirrors ED-U



Backside with fixing

Industrial Mirrors

## EUvex INDUSTRIAL MIRROR



**Application**  
Indoor

**Material**  
Acrylic

**Fixing**  
Post

**Warranty**  
2 years

The EUvex industrial mirror is equipped with its yellow-black frame heightens the attention in industrial areas, both in- and outdoors. Thus, accidents are effectively reduced, and the facility remains operational.

**Material:**

The mirror surface is made of PMMA, UV-stable and weather-resistant. The frame is yellow with black warning marks.



Photo: roand type



Photo: Backside with standard post fixing

Art. No.	Description	Weight	Viewing distance
ED-I 40 x 60	Acrylic, 40 x 60 cm	3,3 kg	9 - 15 m
ED-I 60 x 80	Acrylic, 60 x 80 cm	5,1 kg	15 - 22 m
ED-I 80 x 100	Acrylic, 80 x 100 cm	8,4 kg	22 - 27 m
ED-I 60	Acrylic, roand ø 60 cm	3,7 kg	9 - 15 m
ED-I 80	Acrylic, roand ø 80 cm	5,2 kg	15 - 22 m
ED-Wandarm	Wall fixing, distance 20 cm	1,9 kg	



Photo: fixing for wall mounting  
Art. No. ED-Wandarm



Industrial Mirrors

## EUvex SURVEILLANCE MIRROR



**Application**  
Outdoor and indoor

**Material**  
Acrylic

**Fixing**  
Post

**Warranty**  
2 years

The EUvex observation mirror can be used to monitor production or sales areas. With its distortion-free reproduction it helps prevent accidents and thefts.

**Material:**

The mirror surface is made of PMMA for long term use.

**Fixing Bracket:**

The included flexible fixing bracket as well as the clamp enable easy mounting.



Photo: backside with flexible fixing bracket



Photo: backside with flexible fixing bracket and clamp



**Do you have any questions? Please call us: +49 (0) 51 71 - 58 56 90**

Art. No.	Description	Weight	Viewing distance
EF 30	Acrylic, roand ø 30 cm	0,8 kg	1 - 4 m
EF 40	Acrylic, roand ø 40 cm	0,9 kg	1 - 5 m
EF 50	Acrylic, roand ø 50 cm	1,1 kg	5 - 7 m
EF 60	Acrylic, roand ø 60 cm	1,5 kg	9 - 15 m

Traffic Mirrors

## EUvex TRAFFIC MIRRORS



**Application**  
Outdoor and indoor

**Material**  
Acrylic

**Fixing**  
Post

**Warranty**  
2 years

The EUvex traffic mirror increases safety on roads and premises. Due to its robust design it is suitable for long term outdoor use. The type RA2 reflectors ensure good visibility, even in bad weather conditions.

**Material:**

The EUvex mirror surface is made of PMMA and equipped with red reflectors (Type RA2) on a white frame. It is UV-stable and weather-resistant.



Photo: roand type



Photo: Back side with standard post fixing

Art. No.	Description	Weight	Viewing distance
ED 40 x 60	Acrylic, 40 x 60 cm	4,3 kg	9 - 15 m
ED 60 x 80	Acrylic, 60 x 80 cm	6,8 kg	15 - 22 m
ED 80 x 100	Acrylic, 80 x 100 cm	10,9 kg	22 - 27 m
ED 60	Acrylic, roand ø 60 cm	5,0 kg	9 - 15 m
ED 80	Acrylic, roand ø 80 cm	7,4 kg	15 - 22 m
ED-Wand-arm	Wall fixing, distance 20 cm	1,9 kg	



Photo: fixing for wall mounting  
Art. No. ED-Wandarm

Traffic Mirrors

# EUvex UNIVERSAL MIRRORS



**Application**  
Outdoor and indoor

**Material**  
Acrylic

**Fixing**  
Post

**Warranty**  
2 years

The EUvex universal mirror is equipped with a white frame and very versatile.

**Material**

The EUvex universal mirror surface is made of PMMA, UV-stable and weather-resistant.



Photo: Round version



Photo: Back side with standard post fixing

Art. No.	Description	Weight	Viewing distance
ED-U 40 x 60	Acrylic, 40 x 60 cm	1,8 kg	9 - 15 m
ED-U 60 x 80	Acrylic, 60 x 80 cm	4,0 kg	15 - 22 m
ED-U 80 x 100	Acrylic, 80 x 100 cm	6,6 kg	22 - 27 m
ED-U 60	Acrylic, roand ø 60 cm	2,0 kg	9 - 15 m
ED-U 80	Acrylic, roand ø 80 cm	4,2 kg	15 - 22 m
ED-Wandarm	Wall fixing, distance 20 cm	1,9 kg	



Photo: fixing for wall mounting  
Art. No. ED-Wandarm



# IMPACT PROTECTION MADE OF POLYURETHANE



## IMPACT PROTECTION MADE OF SOLID POLYURETHANE

Why use Polyurethane?

Unlike steel, polyurethane needs no reparation after a collision, as it is non-corrosive.

The material is colored all the way through. Therefore, the product is highly recommended for the food industry.

### Available in following versions:

- Bollards in three diameters.
- Beams in three lengths.
- Hoop guards in seven sizes.

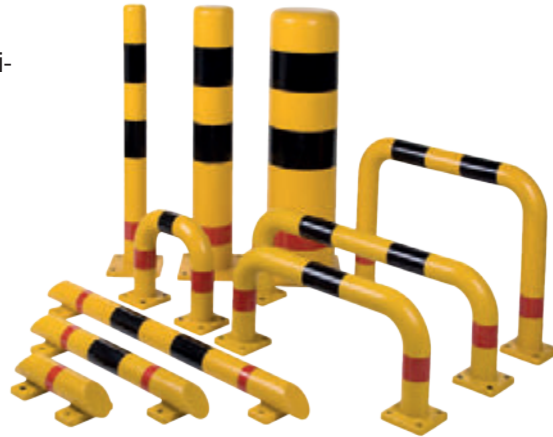

Discover  
all products



Scan me!

### Advantages of Rambowl products:

- One product for outdoor and indoor use
- Extremely impact resistant
- Red reflective warn marking and black stripes for better visibility
- Additionally, steel reinforced for higher stability
- Suitable for use in the food industry
- Non-corrosive
- Fixing via base plate with floor anchors



Photo: Art. No.: P30-50

## PROTECTION BOLLARDS

The bollards provide massive protection for machines, rack installations and entrance gates. The yellow coloring in combination with the red and black reflective stripes ensure high level of visibility.

Three different diameters to cover your needs.

Fixing material available separately.  
For indoor and outdoor use.

**Bollard made of polyurethane, height 1000 mm, with reflecting stripes**



Art. No.	Description	Diameter	Baseplate size	Weight
P50-50	Bollard	ø 90 mm	200 x 200 x 25 mm	11,0 kg
P50-60	Bollard	ø 159 mm	250 x 200 x 25 mm	27,7 kg
P50-70	Bollard	ø 273 mm	320 x 320 x 25 mm	80,2 kg
PFIX1	Fixing set, 4 floor anchors, galvanized, 95 mm length, Ø 10 mm			0,24 kg
PFIX2	Fixing set, 4 floor anchors, stainless steel, 95 mm length, Ø 10 mm			0,24 kg

## PROTECTION BEAMS

The beams are the perfect solution for impact protection and visibly separate forklift traffic routes from pathways.

Fixing material available separately.  
For indoor and outdoor use.

**Beam made of polyurethane, Ø 80 mm, with reflecting stripes**



Art. No.	Description	Diameter	Length	Weight
P60-10	Bar	ø 80 mm	400 mm	3,4 kg
P60-20	Bar	ø 80 mm	800 mm	6,2 kg
P60-30	Bar	ø 80 mm	1200 mm	8,8 kg
PFIX1	Fixing set, 4 floor anchors, galvanized, 95 mm length, Ø 10 mm			0,24 kg
PFIX2	Fixing set, 4 floor anchors, stainless steel, 95 mm length, Ø 10 mm			0,24 kg



# HOOP PROTECTION GUARDS

The hoop protection guards are the perfect solution for protecting buildings, machines, and inventory. The different sizes offer the right product for each type of use.

Fixing material is separately available.  
For indoor and outdoor use.

**Hoop protection guard made of polyurethane, base plate 140 x 140 x 20 mm, Ø 80 mm, with reflecting stripes**

Art. No.	Description	Height	Length	Weight
P30-10	Hoop protection guard	350 mm	375 mm	7,4 kg
P30-20	Hoop protection guard	350 mm	750 mm	9,9 kg
P30-30	Hoop protection guard	350 mm	1000 mm	11,6 kg
P30-40	Hoop protection guard	600 mm	750 mm	14,1 kg
P30-50	Hoop protection guard	600 mm	1000 mm	15,5 kg
P30-60	Hoop protection guard	1200 mm	750 mm	22,5kg
P30-70	Hoop protection guard	1200 mm	1000 mm	24,3 kg
PFIX3	Fixing set, 8 floor anchors, galvanized, 95 mm length, Ø 10 mm			0,48 kg
PFIX4	Fixing set, 8 floor anchors, inox, 95 mm length, Ø 10 mm			0,48 kg

Photo: Art. No.: P30-50

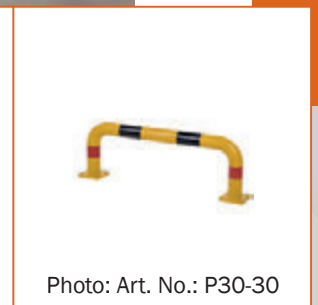
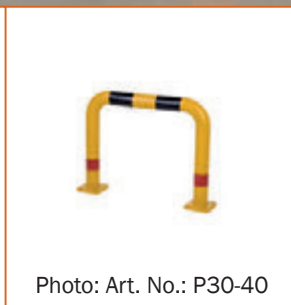
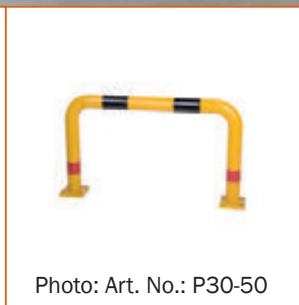
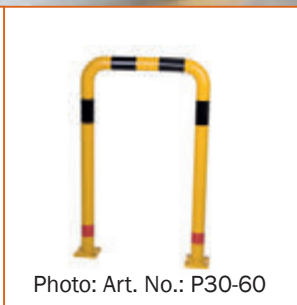
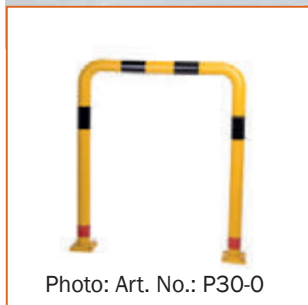
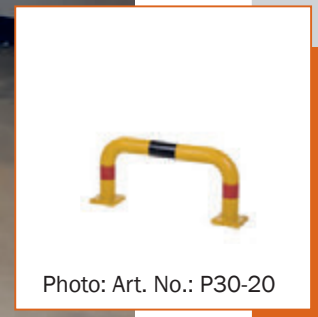
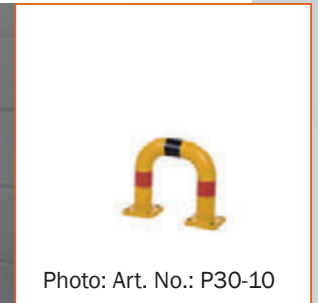

# WARNING AND PROTECTION PROFILES



Profile Type A

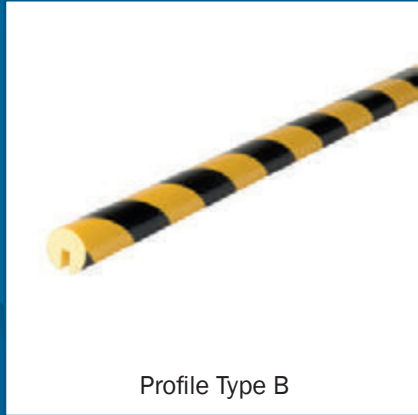

Profile Type B



Profile Type R30



Profile Type F

# WARNING AND PROTECTION PROFILES

Warning and protection profiles are very versatile and can be used on machines, vehicles, walls, corners or in transportation lanes. They are a fail-safe measure to protect both expensive equipment and employees from accidents.

The warning and protection profiles are easily attached due to strong adhesive strips. If necessary, they can be cut to size. Once the protective foil has been removed, the profile only needs to be pressed onto the clean surface for a short amount of time.

A strong, light- and aging-resistant acrylate glue is used on all adhesive profiles (21 N/25 mm).

The warning and protection profiles are available as 1 m pieces, 5 m rolls or in customized lengths (starting with 1 m, exact to 10 cm).

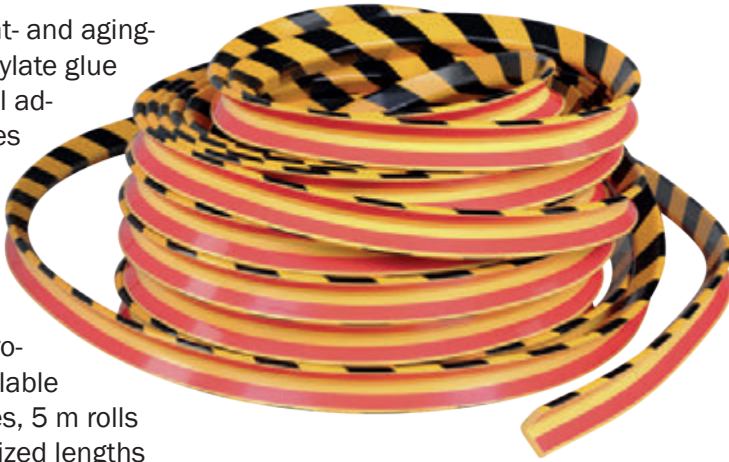

Discover all products



Scan me!





# WARNING AND PROTECTION PROFILES

The warning and protection profiles are available as 1 m pieces, 5 m rolls or in customized lengths (starting with 1 m, exact to 10 cm).

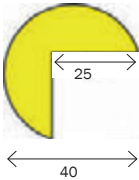
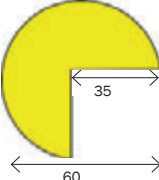
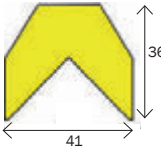
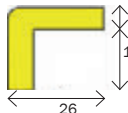
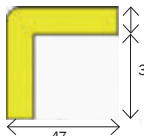
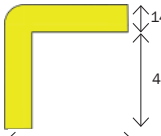

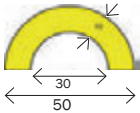
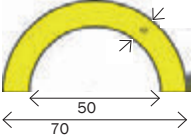
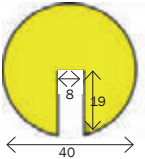
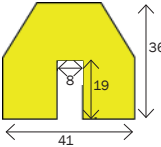
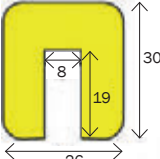
Item	Corner protection					
Profile mm						
	<b>Type A</b>	<b>Type A+</b>	<b>Type AA</b>	<b>Type E</b>	<b>Type H</b>	<b>Type H+</b>
1m-piece Art. No.	10010	11013	11010	10015	11110	11014
Roll Art. No.	10020, 5 m roll	11023, 3 m roll	11020, 5 m roll	10024, 5 m roll	11120, 5 m roll	not available
Running meters Art. No.	10040	11043	11040	10044	11140	not available
Weight / 1,0 m	0,4 kg	0,5 kg	0,5 kg	0,2 kg	0,4 kg	0,7 kg
<b>Fixing</b>	<b>self-adhesive</b>					

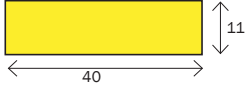
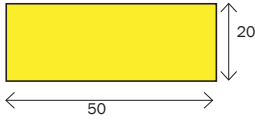
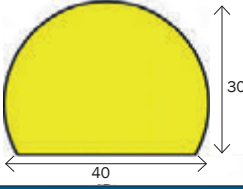
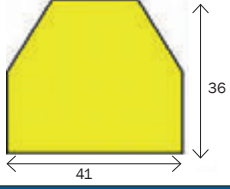
Item	Pipe protection		Edge protection		Edge protection
Profile mm					
	<b>Type R30</b>	<b>Type R50</b>	<b>Type B</b>	<b>Type BB</b>	<b>Type G</b>
1m-piece Art. No.	10017	10014	10011	11011	10019
5 m roll Art. No.	10027	not available	10021	11021	10026
Running meters Art. No.	10047	not available	10041	11041	10046
Weight / 1,0 m	0,4 kg	0,5 kg	0,6 kg	0,6 kg	0,4 kg
<b>Fixing</b>	<b>self-adhesive</b>		<b>to clip on</b>		<b>self-adhesive</b>

Item	Surface protection			
Profile mm				
	<b>Type F</b>	<b>Type D</b>	<b>Type C</b>	<b>Type CC</b>
1m-Piece Art. No.	10016	10013	10012	11012
5 m roll Art. No.	10025	10023	10022	11022
running meters Art. No.	10045	10043	10042	11042
Weight / 1,0 m	0,3 kg	0,5 kg	0,5 kg	0,6 kg
<b>Fixing</b>	<b>self-adhesive</b>			

## CORNER PROTECTION

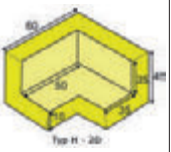
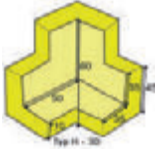
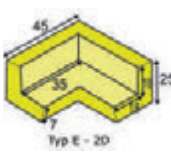
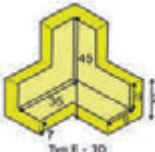

Available in versions for profiles type A, type H and type E, black						
Profile mm						
	<b>Corner Type A, 2D</b>	<b>Corner Type A, 3D</b>	<b>Corner Type H, 2D</b>	<b>Corner Type H, 3D</b>	<b>Corner Type E, 2D</b>	<b>Corner Type E, 3D</b>
Art. No. black	10810	10811	10814	10815	10812	10813
<b>Fixing</b>	<b>self-adhesive</b>					

# ELITMAT

**Elitmat s.r.o.**

Beckovská 32, Nové Mesto n./Váh.  
Slovenská republika  
+421 917 979 772  
info@elitmat.sk

[www.elitmat.sk](http://www.elitmat.sk)

**Elitmat Czech s.r.o.**

Chodovská 228/3, Praha  
Česká republika  
+420 773 931 555  
info@elitmat.cz

[www.elitmat.cz](http://www.elitmat.cz)

**Elitmat GmbH**

Julius Tandler Platz 6/15, Wien  
Österreich  
+43 664 5205 591  
info@elitmat.at

[www.elitmat.at](http://www.elitmat.at)

